

Ghuffi
instrumentos 

DENTAL

DENTAL SURGERY



GD-3848
1234816



GD-3849
1234817



GD-3850

Micro dissecting forceps
180 mm, 7"
1234818



GD-3851

Micro tissue forceps
180 mm, 7"



COOLEY

GD-3852

Atraumatic
micro forceps
180 mm, 7"
1234820



GD-3853

Micro needle holder for suture material
6/0 - 8/0
180 mm, 7"



GD-3854

Micro scalpel with
plastic handle
Sales Unit:
PAK • Package of 5
pieces
165mm, 6 1/4"
12348122



GD-3855

Micro scalpel with
plastic handle
Sales Unit:
PAK • Package of 5
pieces
165mm, 6 1/2"
12348123



GD-3856

Micro scalpel with
plastic handle
Sales Unit:
PAK • Package of 5
pieces
165mm, 6 1/2"
1234824



GD-3857

Titanium scalpel handle for microsurgery blades. round handle. Light, rotatable and handy for precise cutting
145mm, 5/4"



GD-3858

150 mm. Microblade holder with round handle, for precise incisions.



1234825-5-1

Microsurgery blade
Sales unit: PAK =
Package of 10 piece



1234825-2

Microsurgery blade
Sales unit: PAK =
Package of 10 piece



1234825-3

Microsurgery blade
Sales unit: ST =
Package of 1 piece



1234825-4

Microsurgery blade
Sales unit: PAK =
Package of 10 pieces
J>lc:t'CS



1234825-5

Microsurgery blade
Sales unit: PAK =
Package of 10 pieces



1234825-6

Microsurgery blade
Sales unit: ST =
Package of 1 piece



1234825-7

Microsurgery blade
Sales unit: PAK =
Package of 10 pieces



1234825-8

Microsurgery blade
Sales unit: PAK =
Package of 10 pieces



1234825-9

Microsurgery blade
Sales unit: ST =
Package of 1 piece



1/1

GD-3859

No. 3

125 mm, 5"



1/1

GD-3860

145 mm, 5 3/4"



1/1

GD-3861

No. 7

160 mm, 6 1/4"



1/1

1234B26-1



1/1

1234B26-2



1/1

1234B26-3



1/1

1234B26-4
double cutting



1/1

1234B26-5



1/1

1234B26-6



1/1

1234B26-7



1/1

1234B26-8
double cutting

Scalpel blades

Sales unit: PAK = Package of 100 pieces



GD-3862

No. 4

135 mm, 5 1/4"



GD-3863

No. 8

140 mm, 5 1/2"



GD-3864

145 mm, 5 3/4"



1234827-1



1234827-2



1234827-3



1234827-4



1234827-5



1234827-6



1234827-7



1234827-8



1234827-9

Scalpel blades

Sales unit: PAK = Package of 100 pieces



1234828-1

Fig. 10



1234828-2

Fig. 11



1234828-3

Fig. 12



1234828-4

Fig. 15



1234828-5

Fig. 15-C



1234828-6

Fig. 18



1234828-7

Fig. 19



1234828-8

Fig. 20



1234828-9

Fig. 21



1234828-10

Fig. 22



1234828-11

Fig. 23



GD-3865

Fig. 24



1234828-12

Sterile scalpels with plastic handle and blade protector
Sales unit: PAK = Package of 10 pieces





HEISTER
GD-3866
 Mouth gag
 130 mm, 5 1/8"
 1234829



DOYEN-JANSEN
GD-3867
 Mouth gag
 140 mm, 5 1/2"
 1234830



DOYEN-COLLIN
GD-3868
 Mouth gag
 120 mm, 4 3/4"
 1234831

for children



MOLT
GD-3869
 Mouth gag
 100 mm, 4"
 1234832



FERGUSSON-ACKLAND
GD-3870
 Mouth gag
 145 mm, 5 3/4"
 1234833



GD-3871
 Mouth gag
 125 mm, 5"
 1234834



ROSER-KÖNIG

GD-3872

Mouth gag

160 mm, 6 1/4"

1234835



ROSER-KÖNIG

GD-3873

Mouth gag

185 mm, 7 1/4"

1234836



HARTMANN

GD-3874

Nasal speculum

145 mm, 5 3/4"

1234837



GD-3875

STERN BERG

1234838-1 -120 mm, 4¾"

1234838-2 - 130 mm, 5 1/a"

1234838-3 -135 mm, s 1,-

Check and lip retractor

ck

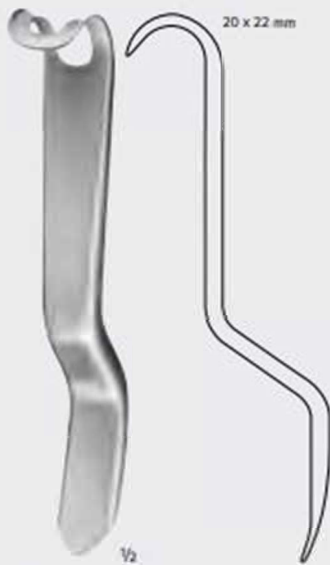

MINNESOTA, modif.

GD-3876

Check retractor

160 mm, 6 ¼"

1234839



GD-3877

Vestibulum hook

140 mm, 5 ½"

1234840



ERGOPLANT

GD-3878

Vestibulum hook

220 mm, 8 ¾"

1234841



GD-3879
Tongue spatula
145 mm, 5 3/4"
1234842



GD-3880
Tongue spatula
140 mm, 5 1/2"
1234843



BUCHWALD
GD-3881
Tongue spatula
180 mm, 7"
1234844



BRUENINGS
GD-3882
Tongue spatula
190 mm, 7 1/2"
1234845



ERGOPLANT
GD-3883
Tongue retractor
190 mm, 7 1/2"
1234846



YOUNG
GD-3884
Tongue Forceps
165 mm, 6 1/2"
1234847



1 pair of rubber
pads for AN705R

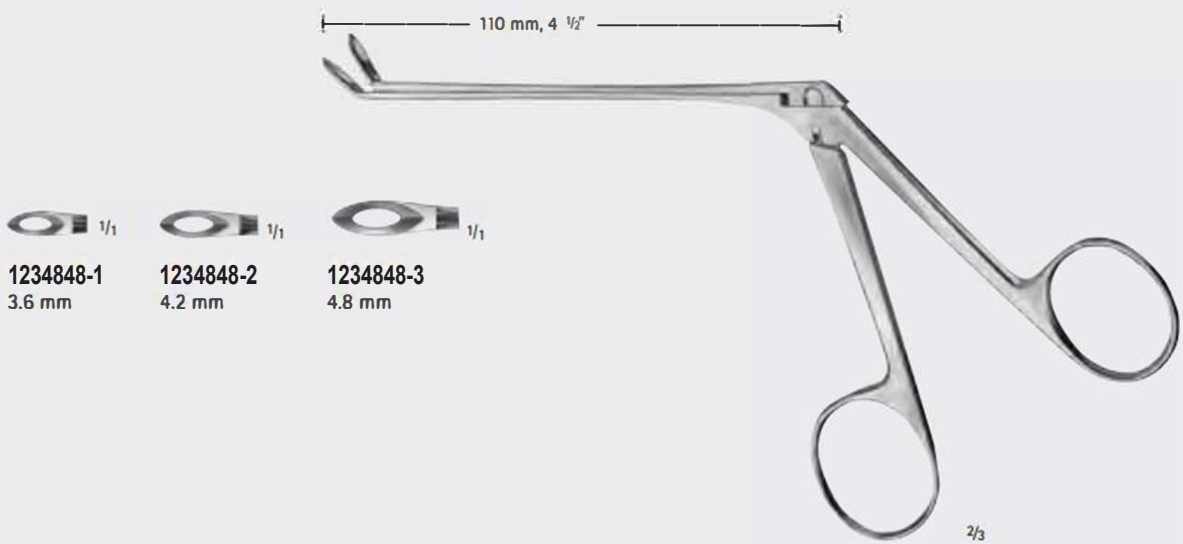

1234848-1
3.6 mm

1234848-2
4.2 mm

1234848-3
4.8 mm

WEIL BLAKESLEY
GD-3885 
Ethmoidal forceps, curved

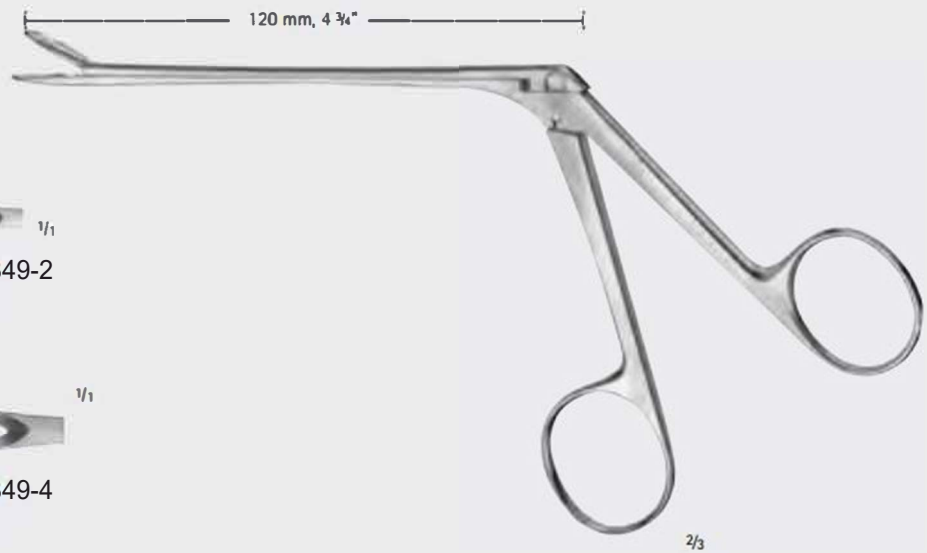

 1/1
1234849-1
3.6 mm

 1/1
1234849-2
4.2 mm

 1/1
1234849-3
4.8 mm

 1/1
1234849-4
5.6 mm

BLAKESLEY-WILDE

GD-3886 

Ethmoidal forceps, straight



HARTMANN 

GD-3887 

Tongue spatula 

1234850 150 mm 

TOBOLD 

GD-3888 

Tongue spatula 

1234851 160 mm 



1/1

GD-3889 
Abdominal and Intestinal
Spatulas
1234852



1/1

GD-3890 
Brain spatula, malleable
double-ended
1234853

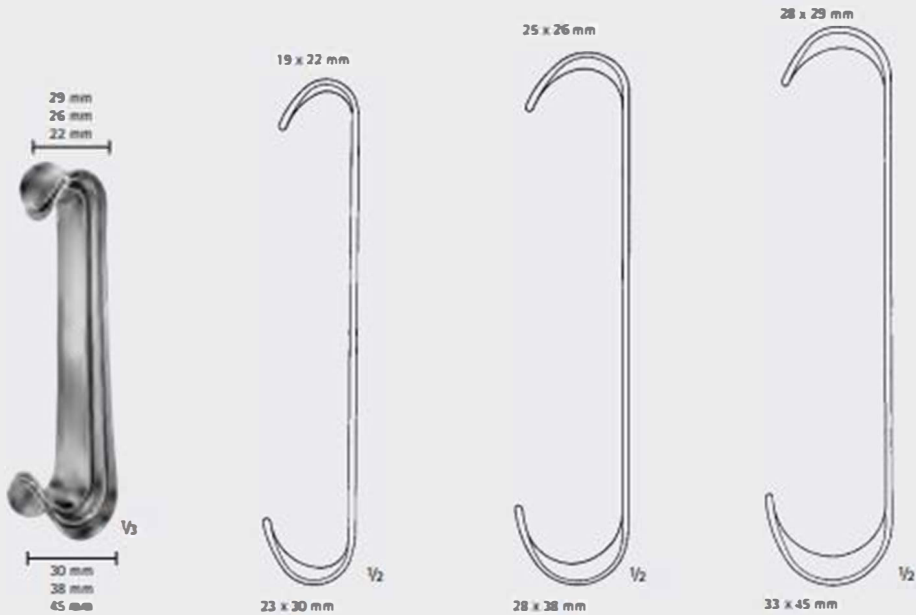

ROUX

GD-3891

1234854-1

1234854-2

1234854-3

Check retractor

Set complete, consisting of: BT031R, BT032R, BT033R

165 mm, 6 1/2"



1234855-1

15 x 15 mm,
220, 8 3/4"

1234855-2

20 x 22 mm,
215 mm, 8 1/2"

1234855-3

28 x 28 mm,
235 mm, 9 1/4"

MIDDELDORPF

GD-3892

Check retractor



RICHTER

GD-3893

Retractor, fig. 3, width of blade 15 mm,
45° 200 mm, 8°

1234856

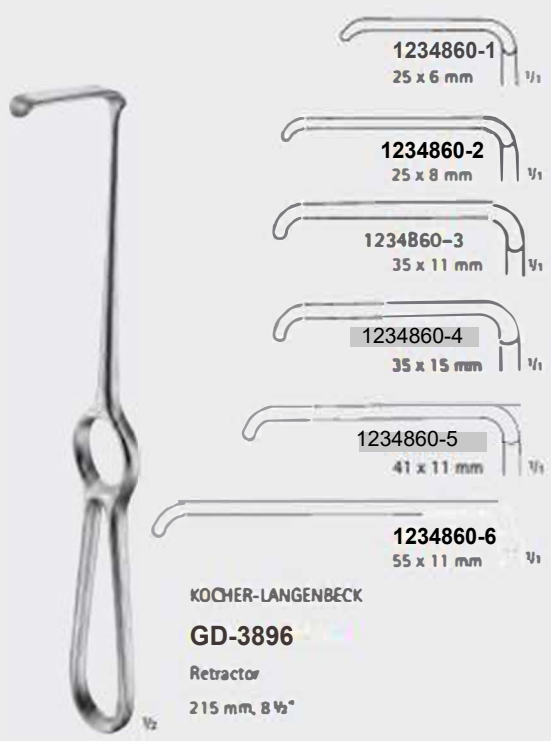
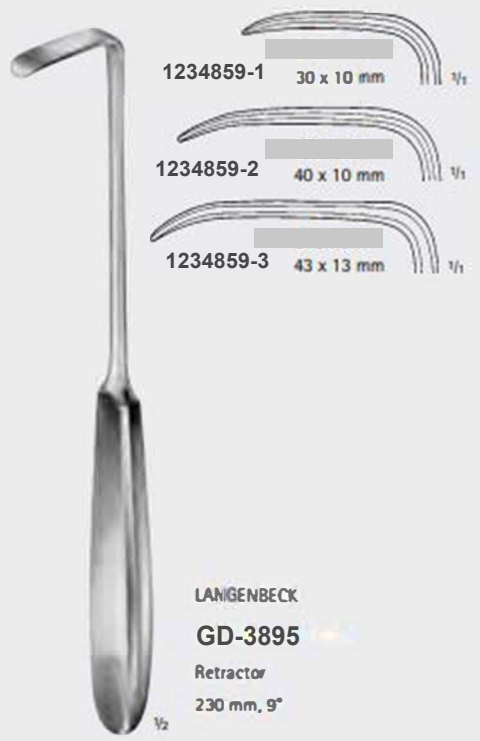



GD-3897
Check retractor
215 mm, 8 1/2"
1234861



GD-38968
Retractor
210 mm, 8 1/4"
1234862

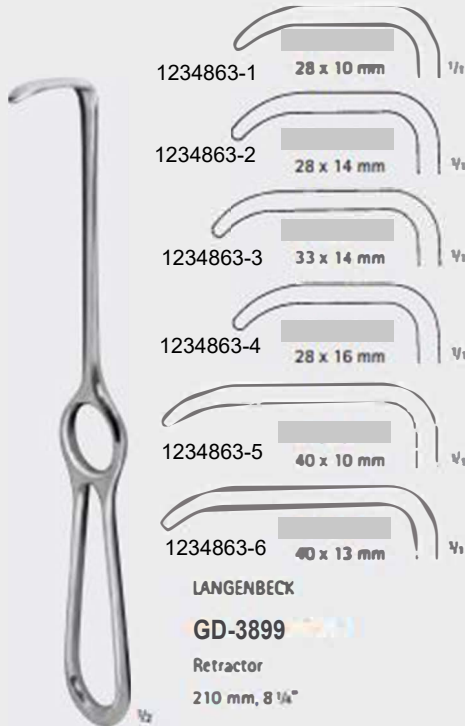



OBWEGESER
GD-3901
Soft tissue retractor
215 mm, 8 1/2"

1/2

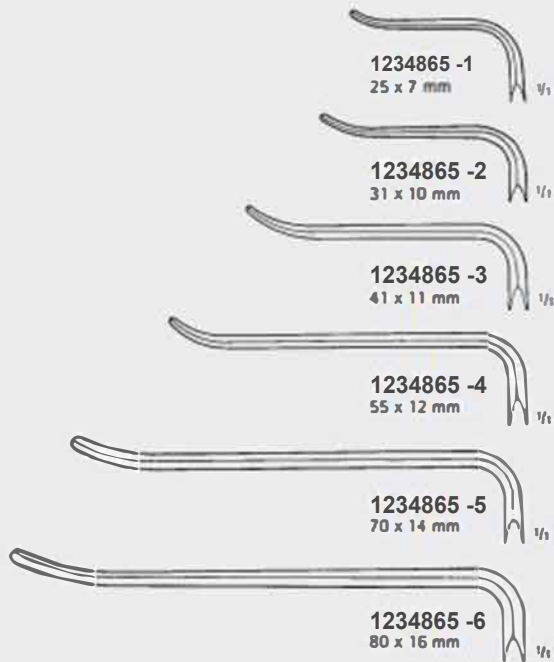

OBWEGESER
GD-3902
Soft tissue retractor
215 mm, 8 1/2"

1/2

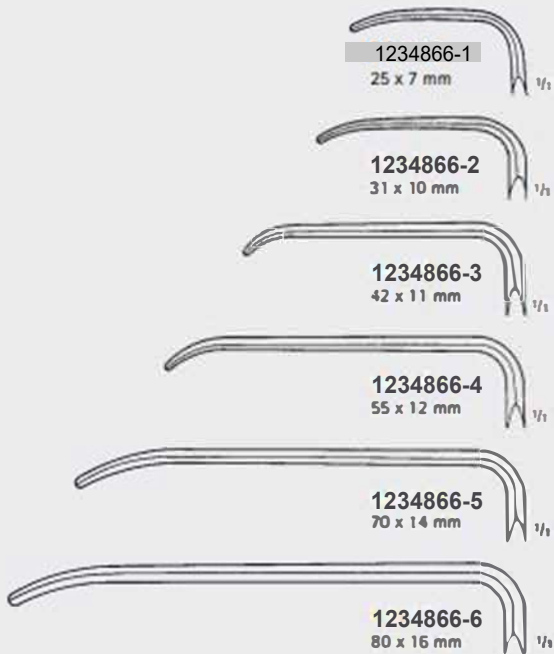



KAY (AUSTIN)
GD-3903
Retractor
1234867



BOWDLER-HENRY
GD-3904
Retractor
190 mm, 7 1/2"
1234868

Especially designed for upper impacted wisdom teeth. The design of the retractor enables the retraction of the cheek and mucoperiosteal flap as well as one hand simultaneous support of retractor and an additional instrument.



LASTER
GD-3905
Cheek retractor
100 mm, 4"
1234869



WARD
GD-3906
Check retractor
155 mm, 6"
1234870



BÜCHS
GD-3907
Retractor for cheeks and soft tissue,
for surgery in the rear maxillofacial
section
205 mm, 8"
1234871



BÜCHS
GD-3908
ERGOPLANT
Soft tissue hook
200 mm, 8"
1234872



KIRSCH
GD-3909
210 mm, 8 1/4"

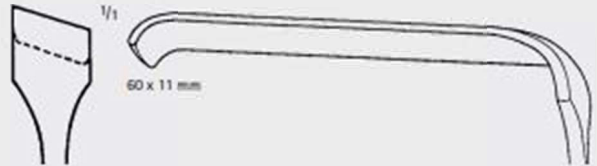

1234873-1
Diagonal check retractors for lateral region, particularly
useful for extraction of wisdom teeth for upper left and
bottom right

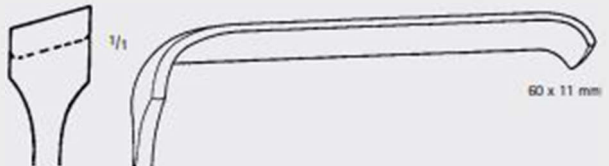

1234873-2
Diagonal check retractors for lateral region, particularly
useful for extraction of wisdom teeth for upper right and
bottom left

10 x 42 mm



OBWEGESER
GD-3910
Spina-nasalis
retractor
215 mm, 8 1/2"
1234874



GD-3911
Ramus retractor
for separation of
ramus and tissue
220 mm, 8 3/4"
1234875



WASSMUND
GD-3912
Retractor
220 mm, 8 3/4"
1234876



wide
1234877-1 20 mm
1234877-2 25 mm
1234877-3 30 mm

GD-3913
Ramus retractor
165 mm, 6 1/2"



DOXHORN
GD-3914
Retractor
210 mm, 8 1/4"



1234878-1
40 x 12 mm

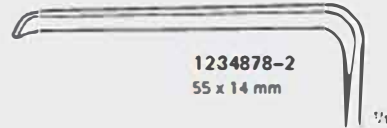

1234878-2
55 x 14 mm



GD-3915
 TESSIER
 Maxillary mobilizers
 right
 150 mm, 6"
 1234879













GD-3916
 TESSIER
 Maxillary mobilizers
 left
 150 mm, 6"
 1234880



GD-3917
 OBWEGESER
 1234881-1 8 mm
 1234881-2
 Channeled retractor
 10 mm
 165 mm, 6 1/2"



GD-3918
 OBWEGESER
 1234882
 Chin retractor
 155 mm, 6"

					
$\frac{1}{2}$	$\frac{1}{2}$	$\frac{1}{2}$	$\frac{1}{2}$	$\frac{1}{2}$	
FRAZIER	GILLIES	GRAEFE	FREER	FOMON	
GD-3919	GD-3920	GD-3921	GD-3922	GD-3923	
130 mm, 5 $\frac{1}{16}$ "	180 mm, 7"	125 mm, 5"	150 mm, 6"	145 mm, 5 $\frac{1}{4}$ "	
1234883					
					
$\frac{1}{2}$	$\frac{1}{2}$	$\frac{1}{2}$	$\frac{1}{2}$	$\frac{1}{2}$	$\frac{1}{2}$
BERGMAN	KILNER	JOSEPH			
GD-3924	GD-3925	GD-3926	1234890-1	1234890-2	1234890-3
140 mm, 5 $\frac{1}{2}$ "	160 mm, 6 $\frac{1}{4}$ "	165 mm, 6 $\frac{1}{2}$ "		3 mm	6 mm
1234888	1234889				1234890-4
					8 mm

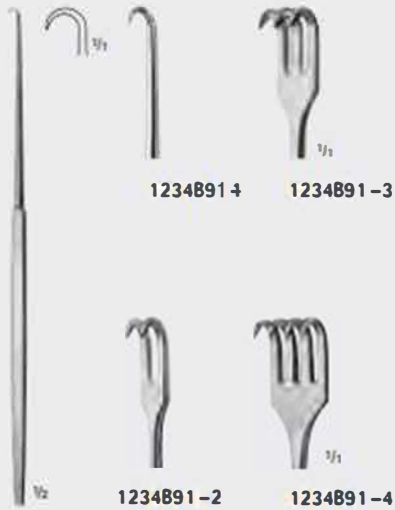

1234891-1

1234891-3

1234891-2

1234891-4

GD-3927

Small curve, sharp

165 mm, 6 1/2"

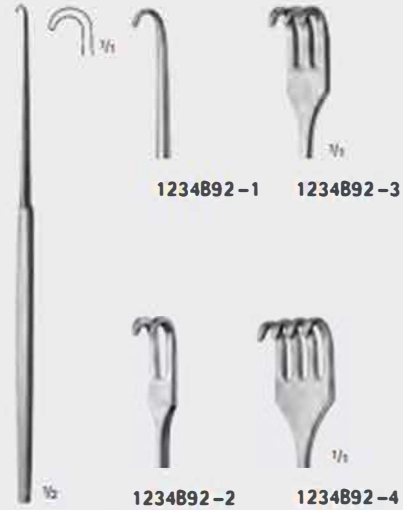

1234892-1

1234892-3

1234892-2

1234892-4

GD-3928

Small curve, blunt

165 mm, 6 1/2"



1234893-1

1234893-2

GD-3929

160 mm, 6 3/4"



1234894-1

16 x 6 mm

1234894-2

24 x 6 mm

LANGENBECK-GRE

EN **GD-3930**

160 mm, 6 1/4"

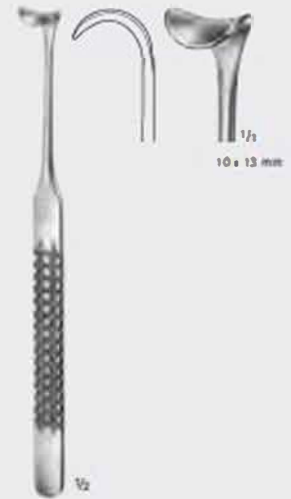

10 x 13 mm

GD-3931

160 mm, 6 3/4"

1234895



GD-3932
Gauze case
1234896



LUNIATSCHEK
GD-3933
Cotton plugger
180 mm, 7°
1234897



LUNIATSCHEK, modif.
GD-3934
Cotton plugger, small
180 mm, 7°
1234898



GD-3935
Retraction thread packer,
flexible
170 mm, 6 3/4°
1234899



BÜCHS
GD-3936
Applicator for
retraction sutures
175 mm, 7°
12349ÜÜ



HAUER
GD-3937
Medicine applicator
135 mm, 5 1/4°
12349Ü1



GD-3938 

Standard patterns



1234902-1
130 mm, 5 1/8"



1234902-2
145 mm, 5 3/4"



COOPER
GD-3939 

Standard patterns



1234903-1
115 mm, 4 1/2"



1234903-2
130 mm, 5 1/8"



1234903-3
145 mm, 5 3/4"

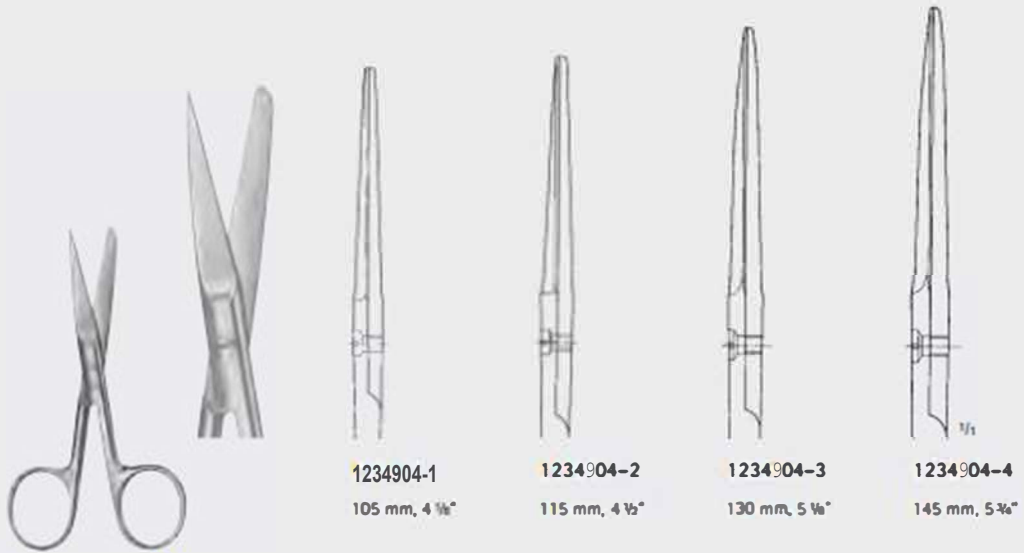

GD-3940 

Standard patterns



GD-3941 

Standard patterns

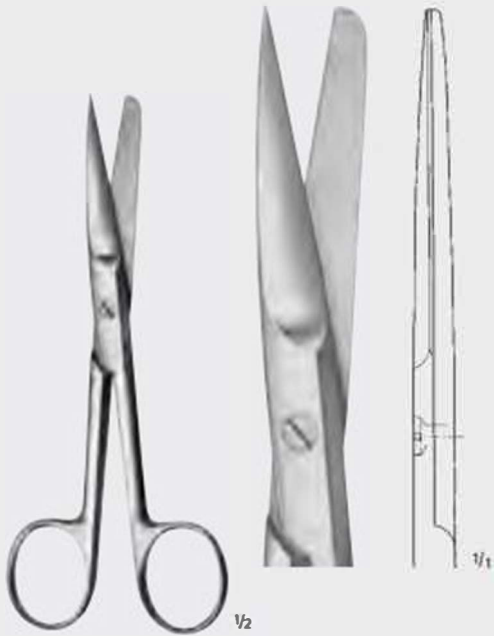

DEAVER

GD-3942

Surgical scissors with flat

lock 145 mm, 5 3/4"

1234906

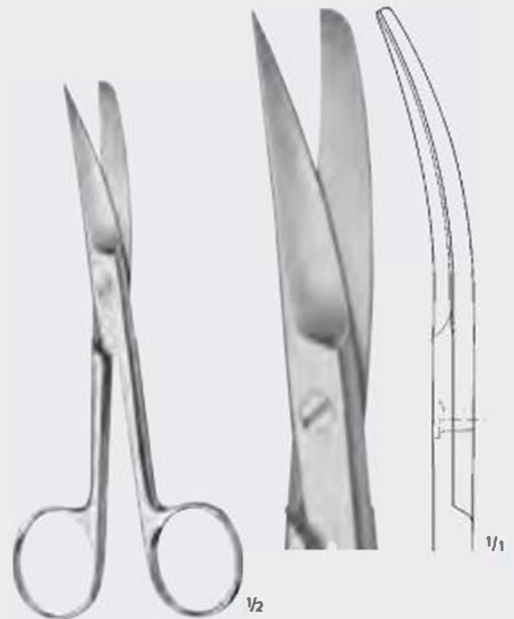

DEAVER

GD-3943

Surgical scissors with flat

lock 145 mm, 5 3/4"

1234907



GD-3944 
Dissecting scissors
115 mm, 4 1/2"

BABY-METZENBAUM
GD-3945 
Dissecting scissors
145 mm, 5 3/4"

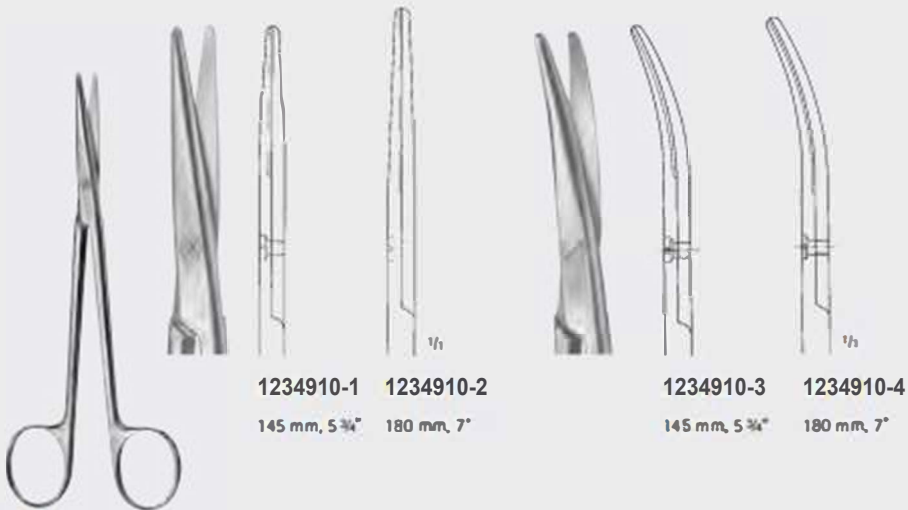

METZENBAUM
GD-3946 
Dissecting scissors

1234910-1 1234910-2
145 mm, 5 3/4" 180 mm, 7"

1234910-3 1234910-4
145 mm, 5 3/4" 180 mm, 7"



1234911-1
125 mm, 5"



1234911-2
150 mm, 6"

KILNER

GD-3947 

Special flat points for dissecting and undermining the skin



GD-3948

Blades outside 
semi-sharp 150 mm, 6"

1234912

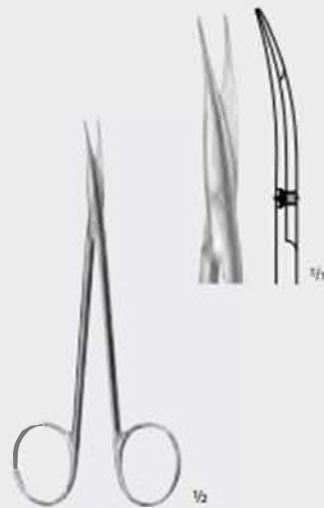

JAMESON-WERBER

GD-3949

130 mm, 5 1/8"

1234913



JAMESON
GD-3950
150 mm, 6"
1234914



REYNOLDS
GD-3951

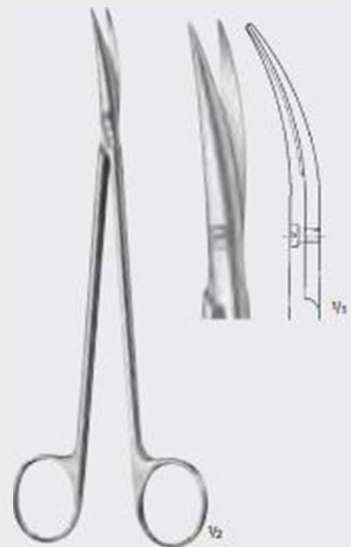

DE BAKY
GD-3952
175 mm, 7"
1234915



GD-3953

90 mm, 3 1/2"



GD-3954

95 mm, 3 3/4"



GD-3955

105 mm, 4 1/8"



GD-3956

115 mm, 4 1/2"

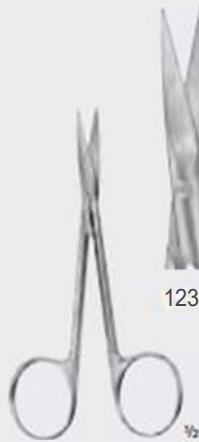

GD-3957

110 mm, 4 3/8"



1234920-1



1234920-2



1234920-3



1234920-4



1234920-5

Curved to side,
especially suited to
remove ligatures



GD-3958

120 mm, 4 3/4"



1234921-1



1234921-2



1234922-1



1234922-2



1234923-1



1234923-2

GD-3959

120 mm, 4^{3/4}°

GD-3960

130 mm, 5^{1/4}°



1234924-1



1234924-2



1234925-1



1234925-2

JOSEPH

GD-3961

150 mm, 6°

KELLY

GD-3962

175 mm, 7°

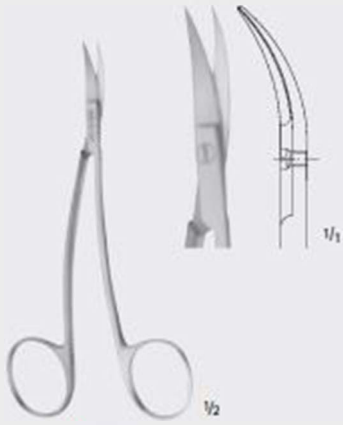

LA GRANGE

GD-3963

1 Blade toothed

110 mm, 4 3/8"

123 4926

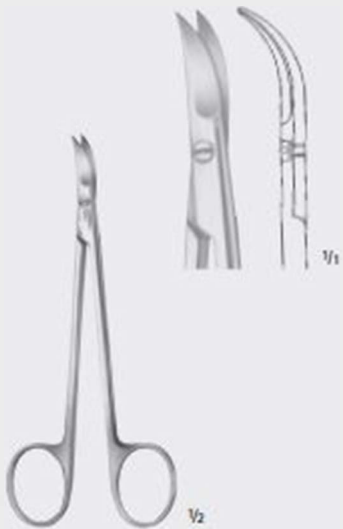

CHADWICK

GD-3964

115 mm, 4 1/2"

123 4927

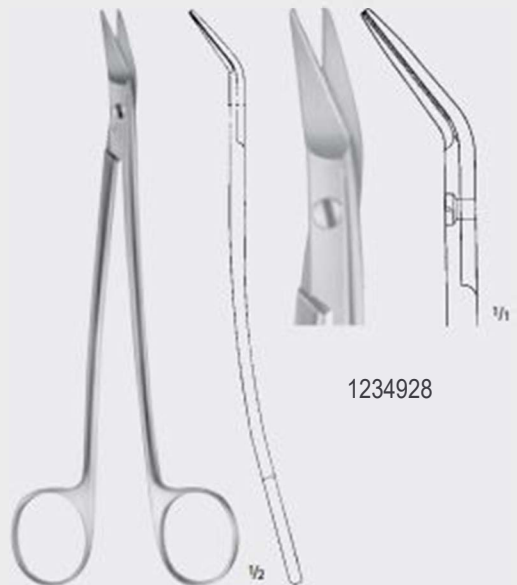

DEAN

GD-3965

Blades serrated

170 mm, 6 3/4"

1234928



1234929-1
very delicate



1234929-2
delicate

TOENNIS-ADSON

GD-3966

175 mm, 7"



1234930-1
135 mm, 5 1/4"



1234930-2
115 mm, 4 1/2"

FOMON

GD-3967



1234931-1



1234931-2

LEXER

GD-3968

narrow

165 mm, 6 1/2"



1234932-1



1234932-2

GD-3969

120 mm, 4^{3/4}"



QUINBY

GD-3970

130 mm, 5^{1/8}"

1234933



GOLDIMAN-FOX

GD-3971

1 Blade toothed, fine

130 mm, 5"

1234934



LOCKLIN

GD-3972

Angled to side, 1 blade toothed

155 mm, 6"

1234935

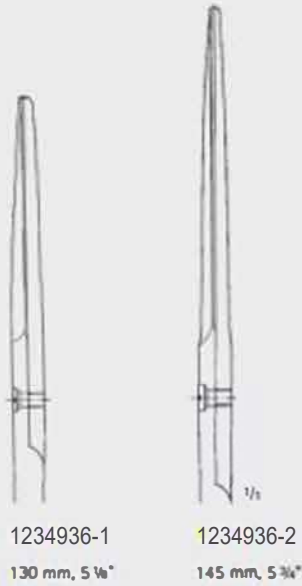

GD-3973

Slender patterns

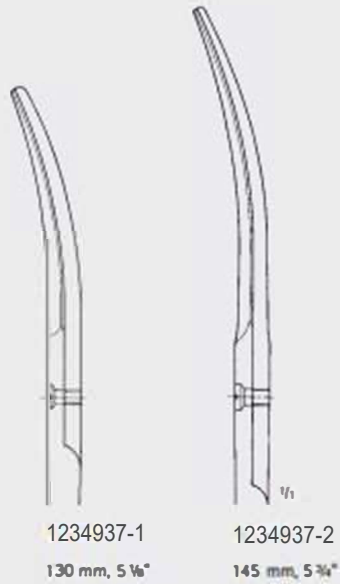

GD-3974

Slender patterns

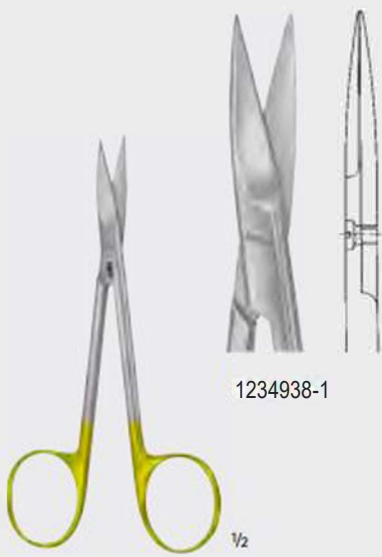

1234938-1



1234938-2

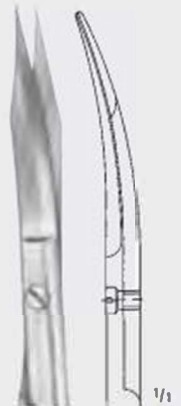

1234939

GD-3975 

120 mm, 4 3/4"



1234939

GOLDMAN-FOX

GD-3976

1 Blade serrated

130 mm, 5 1/8"

1234939



1/2

GD-3977

110 mm, 4 3/8"

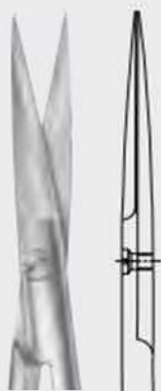

1234940-1



1234940-2



GD-3978

115 mm, 4 1/2"

BABY-METZENBAUM

GD-3979

145 mm, 5 3/4"

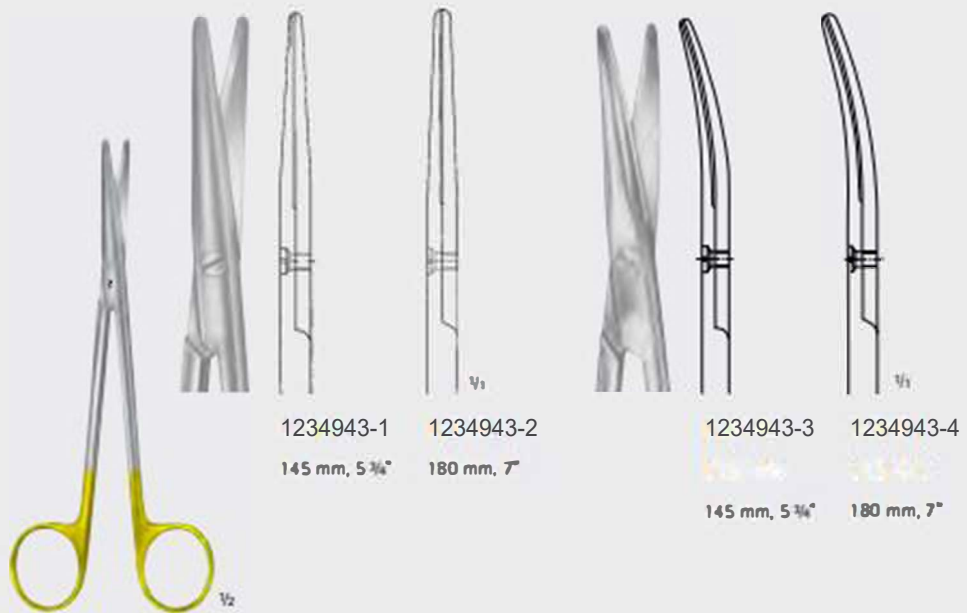

METZENBAUM

GD-3980

1234943-1
145 mm, 5 3/4"

1234943-2
180 mm, 7"

1234943-3
145 mm, 5 3/4"

1234943-4
180 mm, 7"

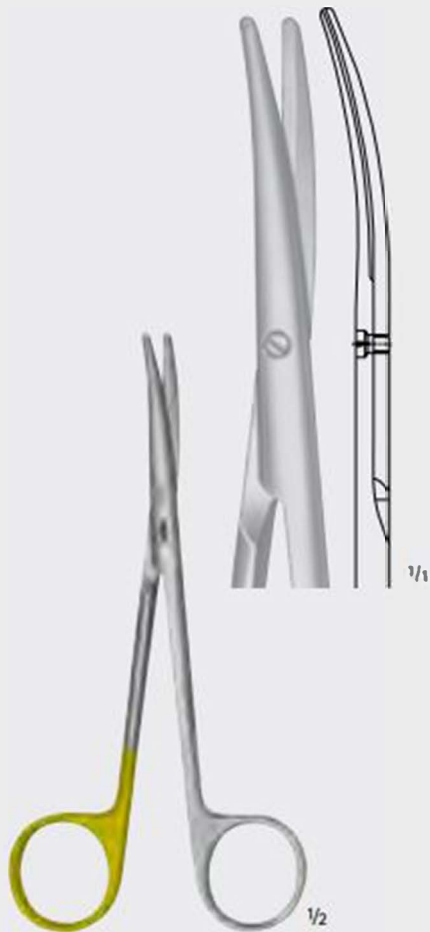

GD-3981

Ligature scissors

145 mm, 5 3/4"

1234944

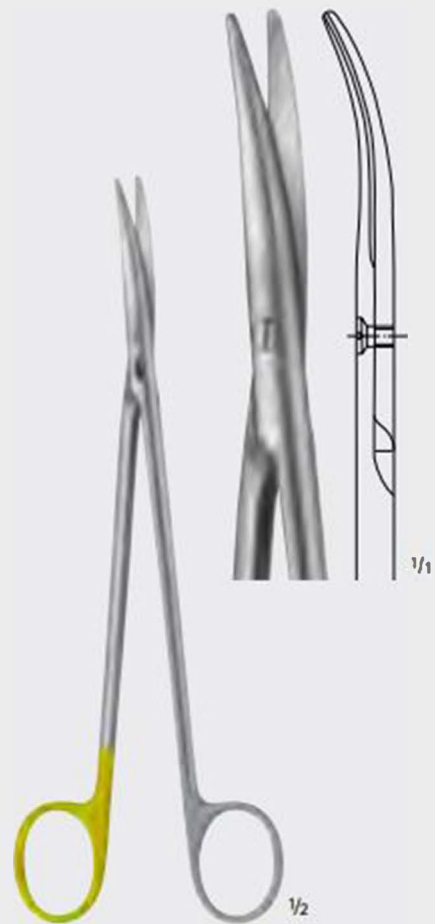

GD-3982

Ligature scissors

180 mm, 7"

1234945

The special qualities of the *Noir*® dissecting scissors allow dissection that is finer than ever before. *Noir*®. Gentle dissection with minimum use of force.



GD-3983
1234946
very delicate
1/2

BABY-METZENBAUM
GD-3984
145 mm, 5 3/4"
very delicate
1/2 1234947

METZENBAUM
GD-3985
145 mm, 5 3/4"
very delicate
1/2 1234948

METZENBAUM
GD-3986
180 mm, 7"
very delicate
1/2 1234949-1 1234949-2

METZENBAUM
GD-3987
200 mm, 8"
very delicate
1/2 1234950-1 1234950-2



METZENBAUM

GD-3988

115 mm, 4 1/2"

1234951



BABY METZENBAUM

GD-3989

145 mm, 5 3/4"

1234952



METZENBAUM

GD-3990 

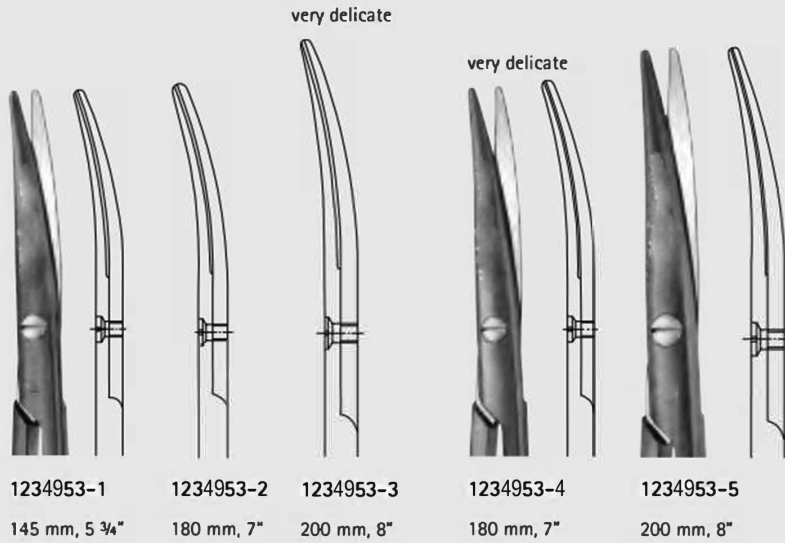



1234954-1 1234954-2
90 mm, 3 1/2" 115 mm, 4 1/2"

SPENCER
GD-3991
Ligature scissors

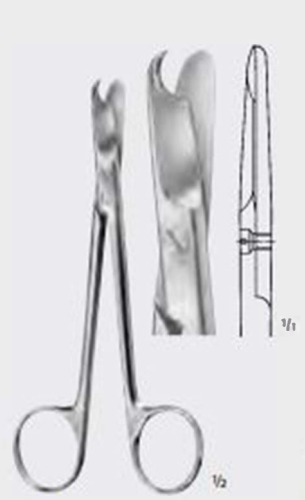

LITTAUER
GD-3992
Ligature scissors
135 mm, 5 1/4"
1234955

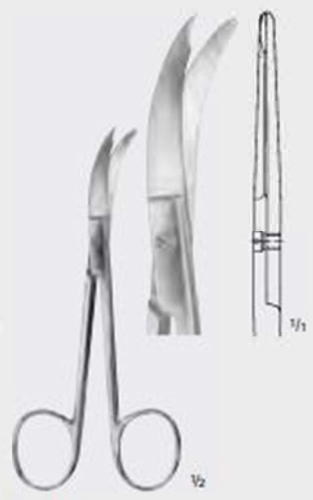

NORTHBENT
GD-3993
Ligature scissors
120 mm, 4 3/4"
1234956



1234957 -1 1234957 -2 1234957 -3 1234957 -4
115 mm, 4 1/2" 140 mm, 5 1/2" 180 mm, 7" 200 mm, 8"

LISTER
GD-3994
Bandage and cloth scissors



MICRO-ADSON

GD-3995

120 mm, 4 3/4"

1234958



MICRO-ADSON

GD-3996

150 mm, 6"

1234959



GD-3997

1234960-1

90 mm,
3 1/2"



1234960-2

105 mm,
4 1/8"



1234960-3

115 mm,
4 1/2"



1234960-4

130 mm,
5 1/8"



1234960-5

145 mm,
5 3/4"

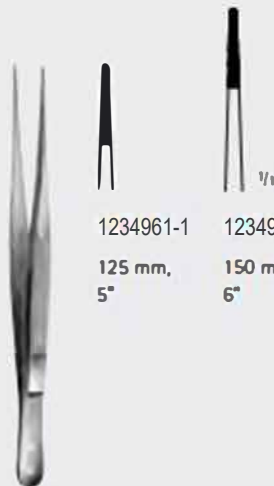

SEMKEN

GD-3998

1234961-1

125 mm,
5"



1234961-2

150 mm,
6"



GD-3999

medium

1234962-1

115 mm,
4 1/2"



1234962-2

130 mm,
5 1/8"



1234962-3

145 mm,
5 3/4"



1234962-4

160 mm,
6 1/4"



1234962-5

180 mm,
7"

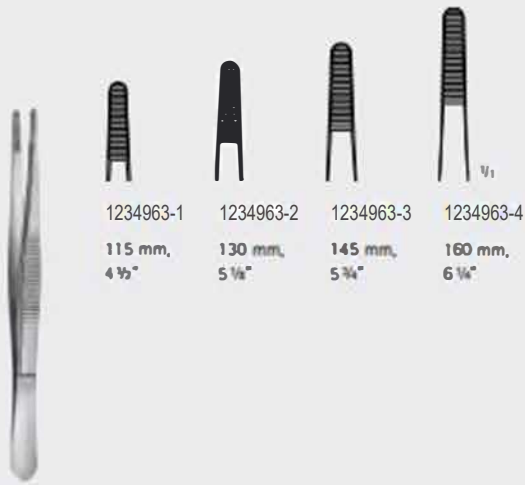

1234963-1 1234963-2 1234963-3 1234963-4
 115 mm, 4 1/2" 130 mm, 5 1/8" 145 mm, 5 3/4" 160 mm, 6 1/4"

STANDARD
GD-4000

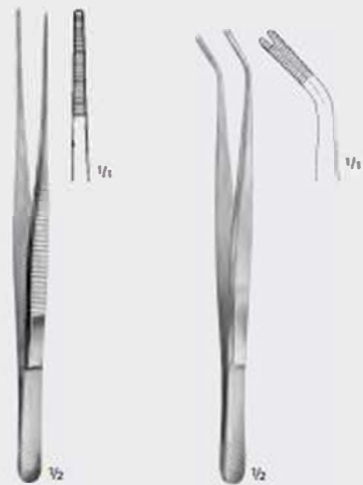

GD-4001
 155 mm, 6"
 1234964

GD-4002
 Suture forceps, angulated
 150 mm, 6"
 1234965



OCHSNER
GD-4003
 Ligature forceps
 145 mm, 5 3/4"
 1234966

PERRY
GD-4004
 130 mm, 5 1/8"
 1234967

GD-4005
 medium

1234968 -1 1234968 -2
 130 mm, 5 1/8" 140 mm, 5 1/2"

BROPHY
GD-4006
 200 mm, 8"

1234969 -1 1234969 -2



1234970 -1
150 mm,
6°



1234970 -2
200 mm,
8°

DE BAKEY

GD-4007



1234971-1
150 mm,
6°



1234971-2
200 mm,
8°

DE BAKEY

GD-4008



DE BAKEY

GD-4009

150 mm, 6°
1234972

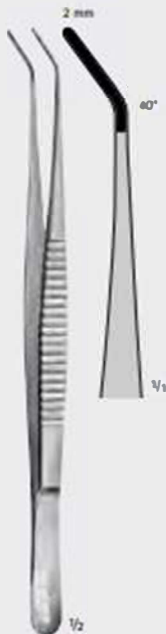

DE BAKEY

GD-4010

200 mm, 8°
1234973



ERGOPLANT

GD-4011

120 mm, 4 3/4°
1234974



ERGOPLANT

GD-4012

For soft tissue
140 mm, 5 1/2°
1234975



ERGOPLANT

GD-4013

120 mm, 4 3/4"

1234976



ADSON

GD-4014

120 mm, 4 3/4"

1234977

For secure grasping of
matrices and interdental
wedges



STANDARD

GD-4015

145 mm, 5 3/4"
1234978



GD-4016

1234979-1

145 mm,
5 3/4"



1234979-2

180 mm,
7"



1234979-3

200 mm,
8"



CUSHING

GD-4017

180 mm, 7"
1234980



GD-4018

150 mm, 6"
1234981

with scraper end

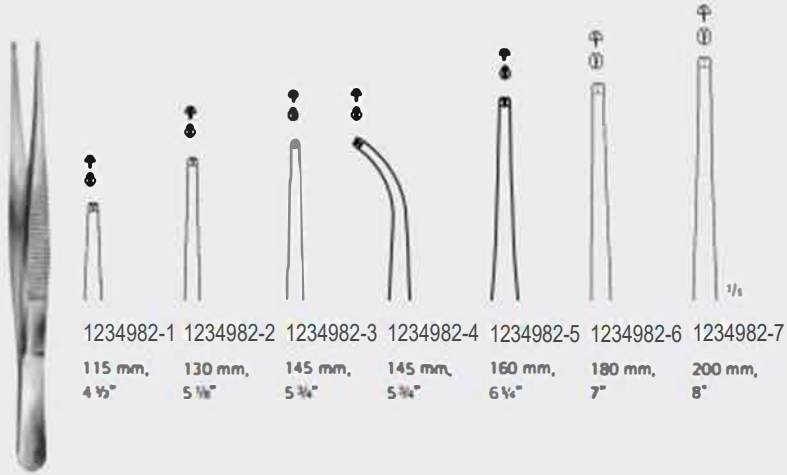

1234982-1	1234982-2	1234982-3	1234982-4	1234982-5	1234982-6	1234982-7
115 mm, 4 1/2"	130 mm, 5 1/8"	145 mm, 5 3/4"	145 mm, 5 3/4"	160 mm, 6 1/4"	180 mm, 7"	200 mm, 8"

GD-4019 
medium

Stronger as BD537R and
BD539R but finer than
BD557R and BD559R

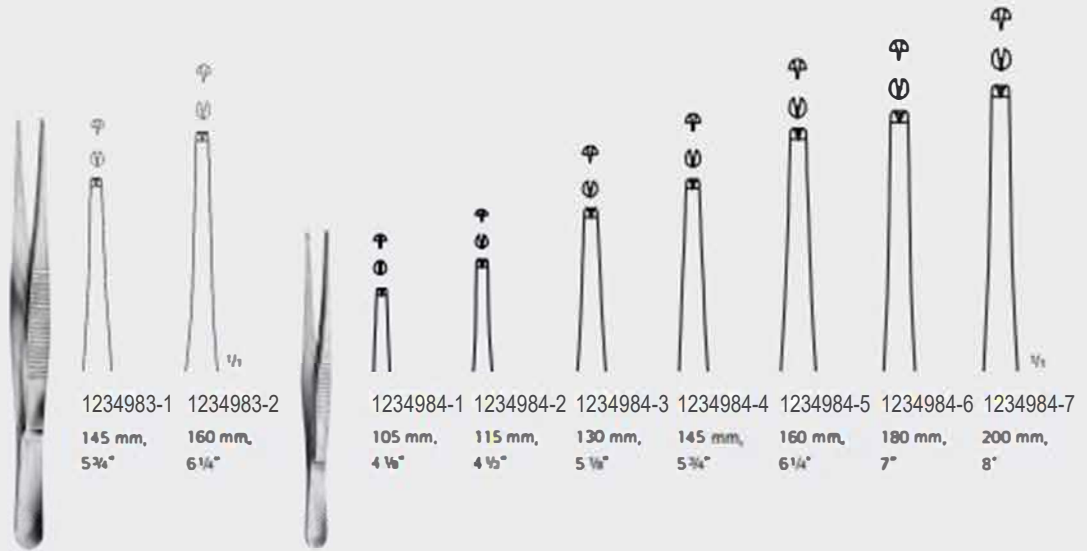

1234983-1	1234983-2	1234984-1	1234984-2	1234984-3	1234984-4	1234984-5	1234984-6	1234984-7
145 mm, 5 3/4"	160 mm, 6 1/4"	105 mm, 4 1/8"	115 mm, 4 1/2"	130 mm, 5 1/8"	145 mm, 5 3/4"	160 mm, 6 1/4"	180 mm, 7"	200 mm, 8"

GD-4020 

STANDARD

GD-4021 



1234985-1
125 mm, 5"

1234985-2
145 mm, 5 3/4"

SEMKEN
GD-4022

MC INDOE
GD-4023
150 mm, 6"
1234986



GILJES
GD-4024
155 mm, 6"
1234987



1234988-1
180 mm, 7"

1234988-2
200 mm, 8"

WAUGH
GD-4025



1234989-1

1234989-2

GERALD
GD-4026
175 mm, 7"



BROPHY
GD-4027
200 mm, 8"
1234990

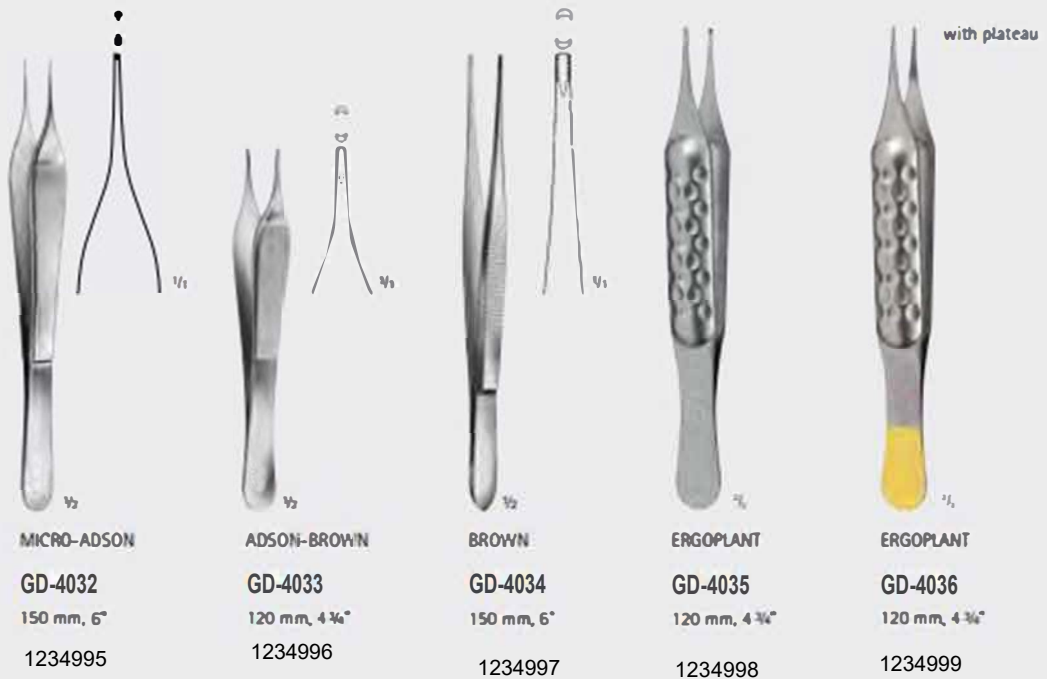
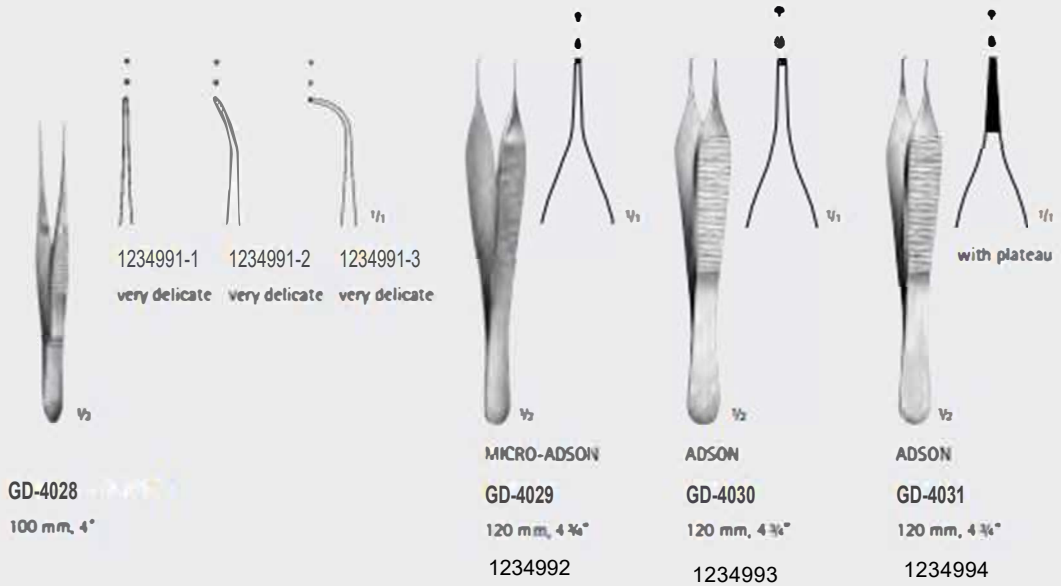



1235000-1 **1235000-2**
130 mm, 5 1/4" 160 mm, 6 1/4"

LISTER

GD-4037

Sponge and dressing
forceps



without ratchet

GD-4038

Sponge and dressing
forceps

145 mm, 5 3/4"
1235001



with ratchet

GD-4039

Sponge and dressing
forceps

145 mm, 5 3/4"
1235002



GD-4040

Sponge and dressing
forceps

175 mm, 7"

1235003

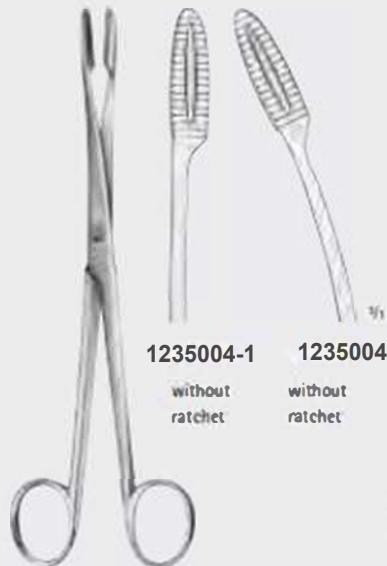

1235004-1

without
ratchet

GROSS

GD-4041

Sponge and dressing
forceps

200 mm, 8"

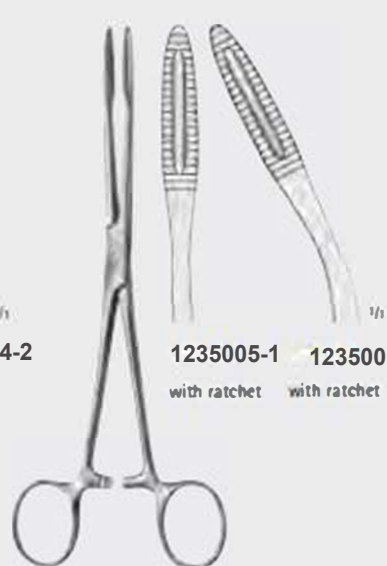

1235004-2

without
ratchet

GROSS

GD-4042

Sponge and dressing
forceps

200 mm, 8"

1235005-1

with ratchet

1235005-2

with ratchet



JONES
GD-4043
Towel Clamp
85 mm, 3 3/8"
1235006



ENGL. MOD.
GD-4044
Towel Clamp
85 mm, 3 3/8"
1235007

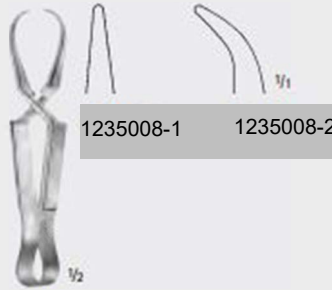

SCHAEDER
GD-4045
Towel Clamp
85 mm, 3 3/8"

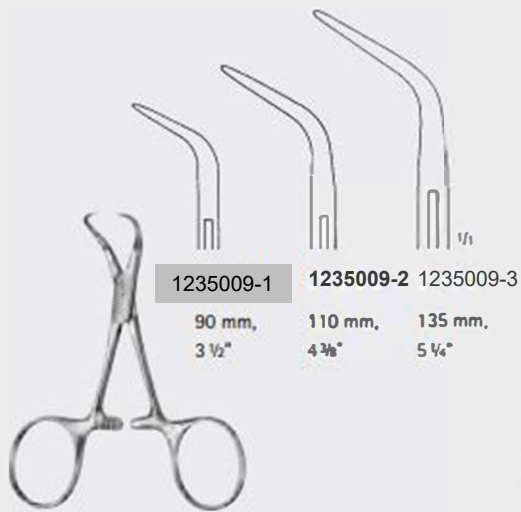

BACKHAUS
GD-4046
Towel Clamp

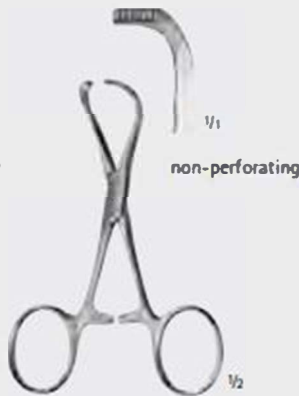

LORNA
GD-4047
Towel Clamp
95 mm, 3 3/4"
1235010



GD-4048
Towel Clamp
140 mm, 5 1/2"
1235011





PEAN

GD-4053

Graße Form
Slender type



1235016-1 1235016-2 1235016-3 1235016-4

130 mm, 5 1/2" 140 mm, 5 1/2" 130 mm, 5 1/2" 140 mm, 5 1/2"



KELLY

GD-4054

140 mm, 5 1/2"



1235017-1 1235017-2



BABY-CRILE

GD-4055

140 mm, 5 1/2"

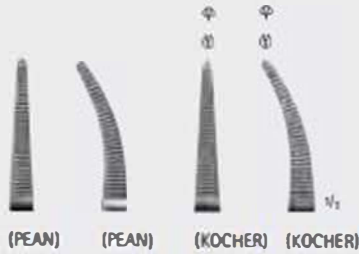

(PEAN) 1235018-1 (PEAN) 1235018-2 (KOCHER) 1235018-3 (KOCHER) 1235018-4



CRILE

GD-4056

140 mm, 5 1/2"

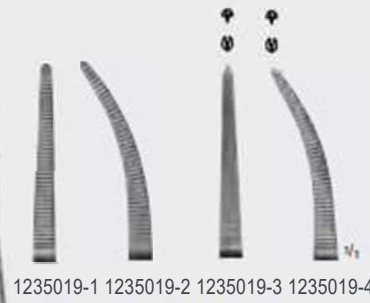

1235019-1 1235019-2 1235019-3 1235019-4

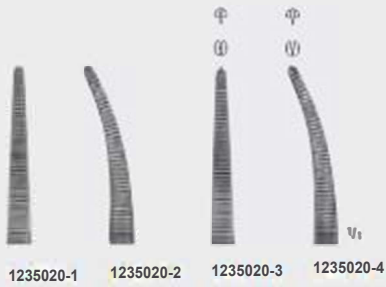

HALSTED
GD-4057
Haemostatic forceps
185 mm, 7 1/4"



RICKLING
GD-4058
Haemostatic forceps
180 mm, 7"



BABY-ALLIS GD-4059
Tissue grasping forceps
130 mm, 5 1/8"
1235022



ALLIS GD-4060
Tissue grasping forceps
155 mm, 6"
1235023

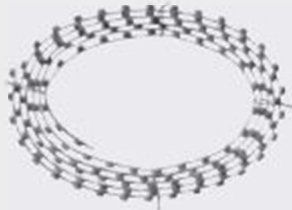

GD-4061

Arch dental splint with hooks, in coils of approx. 40°

1235024



OBWEGESER

GD-4062

Wire and ligature forceps
140 mm, 5 1/2"

1235025



OBWEGESER

GD-4063

Mandibular awl
140 mm, 5 1/2"

1235026



OBWEGESER

GD-4064

Awl for zygomatic arch
230 mm, 9"

1235027



KELSEY FRY

GD-4065

Awl, straight
150 mm, 5 1/2"

1235028



KELSEY FRY

GD-4066

Awl, curved
175 mm, 7"

1235029



OBWEGESER

GD-4067

Maxillary awl
195 mm, 7 3/4"

1235030



PRICHARD
GD-4068
Raspatory
200 mm, 8"
1235031



BUSER
GD-4069
Raspatory
190 mm, 7 1/2"
1235032



STRICKER
GD-4070
ERGOPLANT
Raspatory for fine soft
tissue
190 mm, 7 1/2"
1235033



ψ₁



ψ₁

ψ₁

GD-4071

Raspatory for soft tissue
sharp/blunt

195 mm, 7 3/4"

1235034



ψ₁



ψ₁

ψ₁

BUSER

GD-4072

Micro-Raspatory
180 mm, 7"

1235035

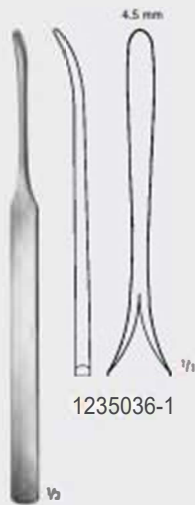

1235036-1

KÖNIG

GD-4073

155 mm, 6"



M 1235036-2



WILLIGER

GD-4074

165 mm, 6 1/2"

1235037



WILLIGER

GD-4075

170 mm, 6 3/4"

1235038

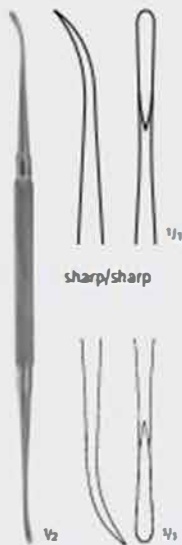

FREER-YASARGIL

GD-4076

185 mm, 7 1/4"

1235039



HALLE

GD-4077

180 mm, 7"

1235040



SYME

GD-4078

185 mm, 7 1/4"

1235041

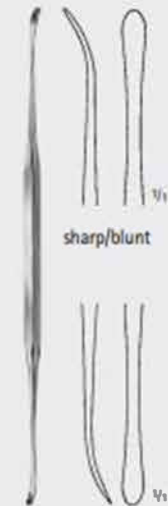

FREER

GD-4079

185 mm, 7 1/4"

1235042



KÖNIG

GD-4080

155 mm, 6"

1235043



WILLIGER

GD-4081

140 mm, 5 1/2"

1235044

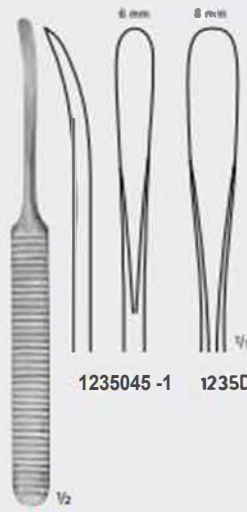

WILLIGER

GD-4082

160 mm, 6 1/4"

1235045 -1

1235045 -2

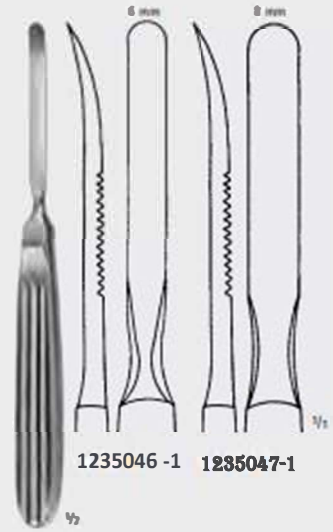

GD-4083

165 mm, 6 1/2"

1235046 -1

1235047-1

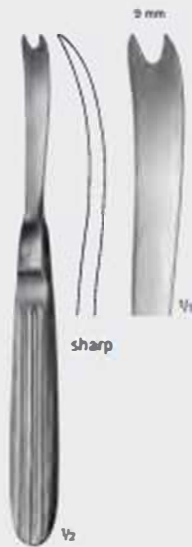

OBWEGESER

GD-4084

170 mm, 6 3/4"

1235048



GD-4085

200 mm, 8"

1235049

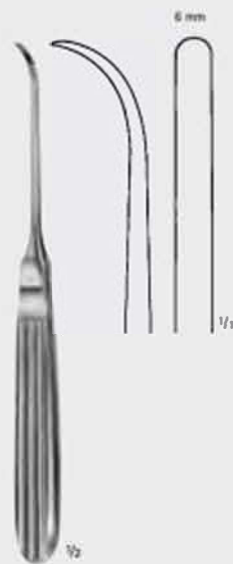

GD-4086

170 mm, 6 3/4"

1235050

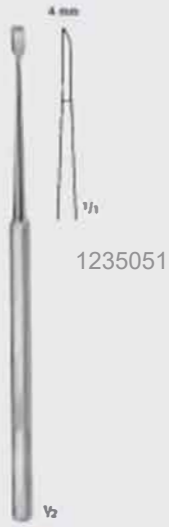

1235051

FREER

GD-4087

160 mm, 6 1/4"



1235052

FREER

GD-4088

160 mm, 6 1/4"

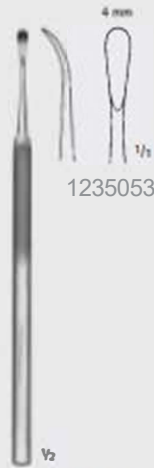

1235053

PARTSCH, mod. LANGE

GD-4089

145 mm, 5 3/4"



sharp/sharp
1235054

MEAD

GD-4090

165 mm, 6 1/2"



sharp/sharp
1235055

MOLT

GD-4091

180 mm, 7"

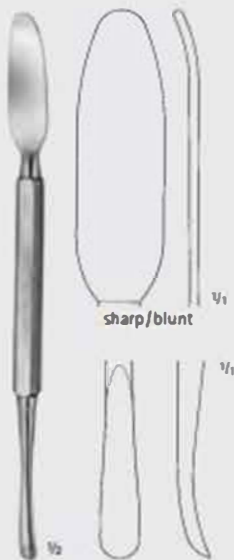

sharp/blunt

ROBERTS

GD-4092

185 mm, 7 1/4"

1235056



sharp/sharp

SELDIN

GD-4093

195 mm, 7 3/4"

1235057

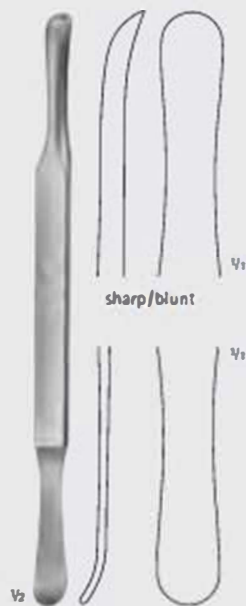

sharp/blunt

SELDIN

GD-4094

200 mm, 8"

1235058



sharp/blunt

HOWARTH

GD-4095

215 mm, 8 1/2"

1235059



1235060
shortly curved

4 mm

MÜHLING

GD-4096

170 mm, 6 3/4"

Range of application:

- For loosening parts of the mucosa
- For cyst resection
- For parodontal surgery



BÜCHS

GD-4097

190 mm, 7 1/2"

1235061



4 mm

1/1

GD-4098

for palate, left
140 mm, 5 1/2"

1235062



4 mm

1/1

GD-4099

for palate, right
140 mm, 5 1/2"

1235063



3.2 mm

1/1

PARTSCH

GD-4100

150 mm, 6"

4.6 mm

1/1

1235064-1

1235064-2



5.5 mm

1/1

WARD

GD-4101

170 mm, 6 3/4"

1235065



LUCAS

GD-4102

190 mm, 7 1/2"
1235066



LUCAS

GD-4103

180 mm, 7"
1235067



LUCAS

GD-4104

185 mm, 7 1/4"
1235068



JANSEN

GD-4105

160 mm, 6 1/4"
1235069



JANSEN

GD-4106

160 mm, 6 1/4"
1235070



HEMINGWAY

GD-4107

170 mm, 6 3/4"
1235071



HEMINGWAY

GD-4108

170 mm, 6 3/4"
1235072



HEMINGWAY

GD-4109

Fig. 0
170 mm, 6 3/4"
1235073



HEMINGWAY

GD-4110

Fig. 1
170 mm, 6 3/4"
1235074



HEMINGWAY

GD-4111

Fig. 2
170 mm, 6 3/4"
1235075



HEMINGWAY

GD-4112

Fig. 3
170 mm, 6 3/4"
1235076



HEMINGWAY

GD-4113

Fig. 4
170 mm, 6 3/4"
1235077

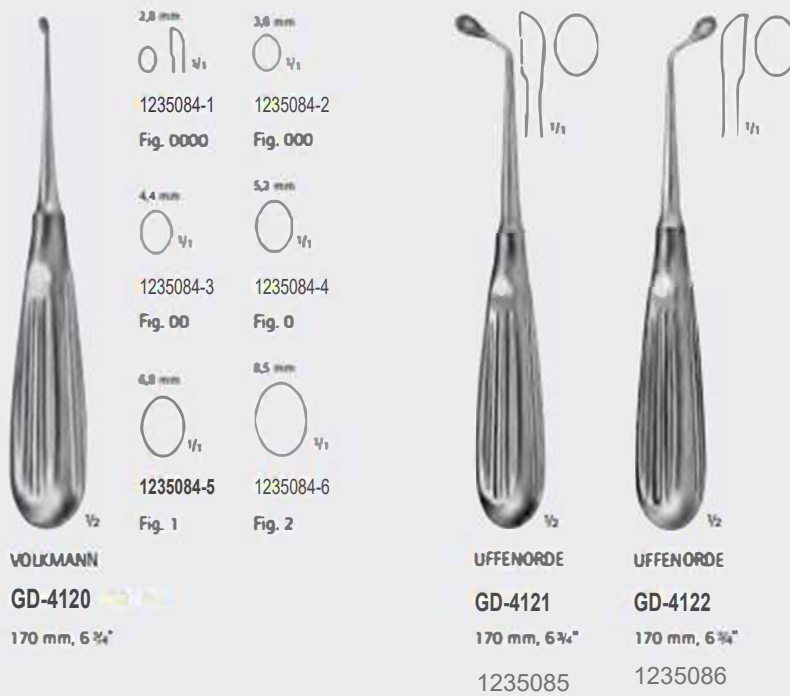
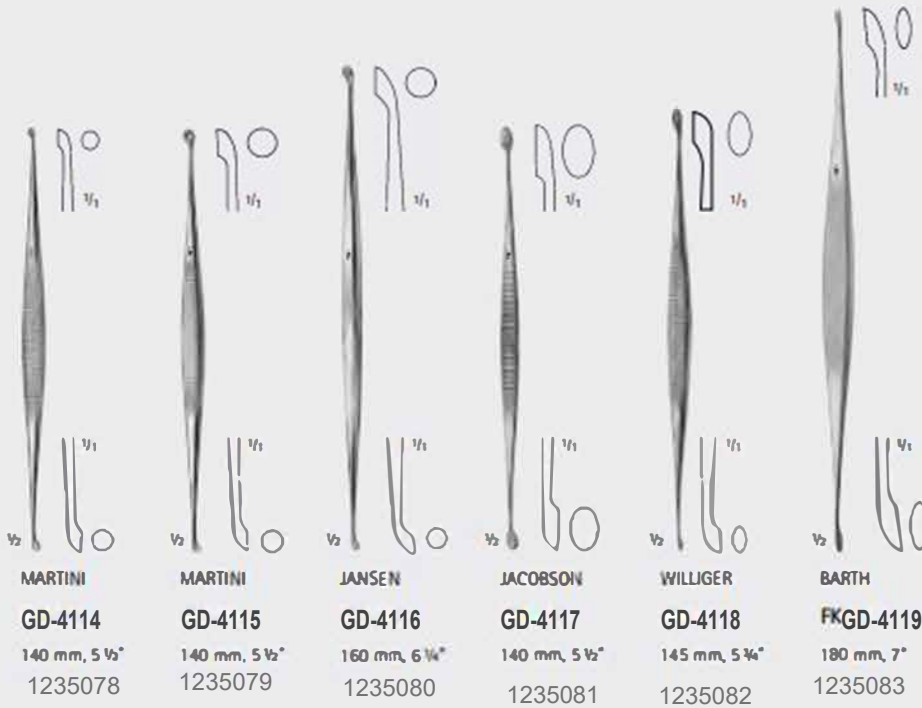



GD-4123
Bone Curette
175 mm, 7"
1235087



MILLER
GD-4124
Bone Curette
180 mm, 7"
1235088



SCHLUGER
GD-4125
FS 9/10S
Periodontal file
170 mm, 6 3/4"
1235089



SUGARMAN
GD-4126
FS 3/4S
Periodontal file
170 mm, 6 3/4"
1235090



MILLER
GD-4127 Bone
files
180 mm, 7"



1235091-1



1235091-2



1235091-3



5 mm



4.3 mm



5 mm



MILLER
GD-4128
ERGOPLANT
Bone file
195 mm, 7 3/4"
1235092

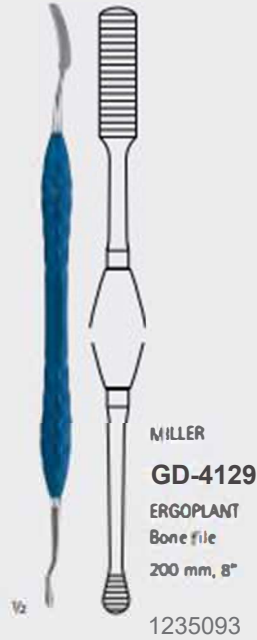

MILLER
GD-4129
ERGOPLANT
Bone file
200 mm, 8"
1235093



GD-4130

LAMBOTTE

- 1235094-1 4 mm
- 1235094-2 6 mm
- 1235094-3 8 mm
- 1235094-4 10 mm
- 1235094-5 12 mm
- 1235094-6 15 mm

Osteotomes
125 mm, 5"



GD-4131

1235095-1 4 mm

- 1235095-2 6 mm
- 1235095-3 8 mm
- 1235095-4 10 mm
- 1235095-5 12 mm

Osteotomes
140 mm, 5 1/2"



GD-4132

PARTSCH

- 1235096-1 3 mm
- 1235096-2 4 mm
- 1235096-3 5 mm
- 1235096-4 6 mm

Chisets

140 mm, 5 1/2"



GD-4133

PARTSCH

- 1235097-1 2 mm
- 1235097-2 4 mm
- 1235097-3 5 mm
- 1235097-4 6 mm
- 1235097-5 7 mm

Chisets

170 mm, 6 3/4"



GD-4134

PARTSCH

- 1235098-1 3 mm
- 1235098-2 4 mm
- 1235098-3 5 mm
- 1235098-4 6 mm

Gouges

140 mm, 5 1/2"

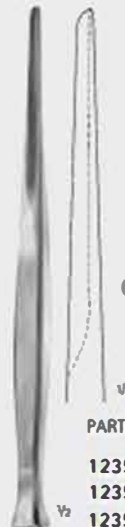

GD-4135

PARTSCH

- 1235099-1 3 mm
- 1235099-2 4 mm
- 1235099-3 5 mm
- 1235099-4 6 mm
- 1235099-5 8 mm

Gouges

170 mm, 6 3/4"



FREER

GD-4136 4 mm

Chisel

160 mm, 6 1/4"

1/16 1235100-



FREER

GD-4137 4 mm

Chisel, curved

160 mm, 6 1/4"

1/16 1235101



LUCAS

GD-4138 4 mm

D0713R 6 mm

Chisel

160 mm, 6 1/4"

1/16 1235102



LUCAS

D0715R 3 mm

D0717R 5 mm

Gouges

160 mm, 6 1/4"

GD-4139

1/16 1235103



OCHSENBEIN
GD-4140
MCO 1/2
Mini chisel
for shaping bone
contours
170 mm, 6 3/4°
1235104



RHODES
GD-4141
CR36/37
Mini chisel
for shaping bone
contours
165 mm, 6 1/2°
1235105



RHODES
GD-4142
M CR 36/37
Mini chisel
for shaping bone
contours
165 mm, 6 1/2°
1235106



**KRAMER-
NEVINS**
GD-4143
M CKN 1/2
Mini chisel for
dissection of soft
and hard tissues
165 mm, 6 1/2°
1235107



**EAST GRINSTEAD
(WARD)**
GD-4144
3 mm
5 mm
Chisels
180 mm, 7°
1235108



**EAST GRINSTEAD
(WARD)**
GD-4145
3 mm
5 mm
Osteotomes
180 mm, 7°
1235109

○ 1235110-1
Ø 3 mm

○ 1235110-2
Ø 5 mm

○ 1235110-3
Ø 7 mm



GD-4146
Tampers for bone grafts
can also be used as
haemostatic chisels
160 mm, 6 1/2"



PASSOW
GD-4147
Tampers for bone grafts
can also be used as
haemostatic chisels
120 mm, 4 3/4"

□ 1235111-1
2.5 mm

1/2 □ 1235111-2
3.5 mm



OBWEGESER
1235112 11 mm
Pterygomaxillary
osteotome, curved, for
anterior displacement
of maxilla
235 mm, 9 1/4"

GD-4148



NIEDERDELMANN
1235113 8 mm
DO730R 10 mm
Osteotomes, curved,
for sagittal splitting
procedure of the lower
jaw
250 mm, 10"

GD-4149



COTTLE
1235114-1 4 mm
1235114-2 6 mm
1235114-3 8 mm
1235114-4 10 mm
1235114-5 12 mm
Osteotome with
depth markings
180 mm, 7"
GD-4150



COTTLE
1235115-1 4 mm
1235115-2 7 mm
1235115-3 9 mm
1235115-4 12 mm
Chisel-Osteotomes
with depth markings
180 mm, 7"
GD-4151



COTTLE
1235116 6 mm
Osteotome with
depth markings
180 mm, 7"
GD-4152



- 1235117-1 10 mm
- 1235117-2 15 mm
- 1235117-3 20 mm

Chisel, straight
with PEEK-handle
200 mm, 8"

GD-4153



- 1235118-1 10 mm
- 1235118-2 15 mm
- 1235118-3 20 mm

Chisel, curved
with PEEK-handle
200 mm, 8"

GD-4154

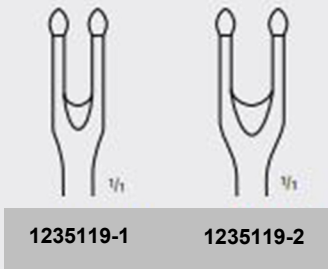

1235119-1

1235119-2

- DO704R 4 mm
- DO706R 6 mm

Osteotome
185 mm, 7 1/4"

GD-4155



DF112R 80 g
165 mm, 6 1/2"
GD-4156
1235120



DF114R 155 g
190 mm, 7 1/2"
GD-4157
1235121



FL036R 135 g
With interchangeable
plastic disks
185 mm, 7 1/4"
GD-4158
Pair of spare disks
1235122



MEAD
FL035R 180 g
With interchangeable
plastic disks
190 mm, 7 1/2"
GD-4159
Pair of spare disks
1235123



Ø 30 mm

COTTLE

FL038R 235 g

1 Side flat

1 Side convex

185 mm, 7 1/4"

GD-4160

1235124

1/2



Ø 27 mm

HAJEK

FL044R 135 g

220 mm, 8 3/4"

GD-4161

1235125

1/2



Ø 25 mm

ERGOPLANT Mallet,
with interchangeable plastic disks

200 mm, 8"

GD-4162

Pair of spare disks

1235126

1/2



GD-4163

Reposition forceps with stepped tips,
long ratchet

95 mm, 3 3/4"

1235127

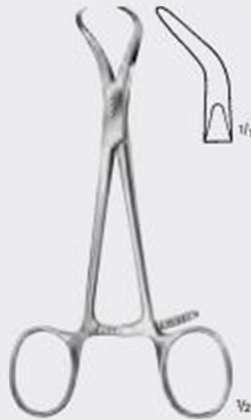

GD-4164

Reposition forceps for small
fragments 135 mm, 5 1/4"

1235128

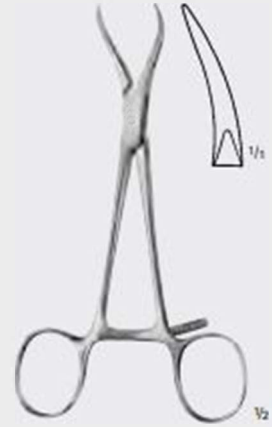

GD-4165

Reposition forceps,
especial for maxillary reposition

135 mm, 5 3/4"

1235129



HAASE

GD-4166

Reposition forceps for mandibular fractures

165 mm, 6 1/2"

1235130

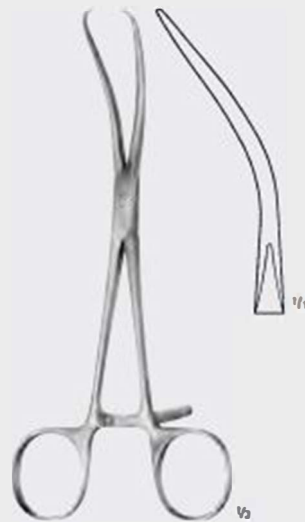

REILL

GD-4167

Reposition forceps

170 mm, 6 3/4"

1235131



GD-4168

Bone holding forceps
200 mm, 8"
1235132



DINGMANN

GD-4169

Bone holding forceps
185 mm, 7 1/4"
1235133



DINGMANN, modif.

GD-4170

Bone holding forceps
185 mm, 7 1/4"
1235134



LUER-FRIEDMANN
GD-4171
ERGOPLANT
145 mm, 5 3/4"
1235135



LUER-FRIEDMANN
GD-4172
145 mm, 5 3/4"
1235136



GD-4173
150 mm, 6"
1235137



GD-4174
140 mm, 5 1/2"
1235138



LUER
GD-4175
150 mm, 6"
1235139



LUER
GD-4176
155 mm, 6"
1235140



SCHWARZ
GD-4177
145 mm, 5 3/4"
1235141



BLUMENTHAL
GD-4178
155 mm, 6"
1235142



BLUMENTHAL
GD-4179
155 mm, 6"
1235143



STELLBRINK
GD-4180
175 mm, 7"
1235144



STELLBRINK
GD-4181
170 mm, 6 3/4"
1235145



BEYER
GD-4182
180 mm, 7"
1235146



GD-4183

ERGOPLANT Bone cutting forceps, curved

130 mm, 5 1/8"

1235147



STAMM

GD-4184

Bone cutting forceps

150 mm, 6"

1235148



MEAD

GD-4185

Bone rongeur

165 mm, 6 1/2"

1235149



BANE-HARTMANN

GD-4186

Bone rongeur

175 mm, 7"

1235150



BEYER

1235151-1

GD-4187

Bone rongeur

180 mm, 7"

ZAUFAL-JANSEN

1235151-2



HALSEY

GD-4188

Needle holder

130 mm, 5 1/8"
1235152



BAUMGARTNER

GD-4189

Needle holder

145 mm, 5 3/8"
1235153



CRILE-MURRAY

GD-4190

Needle holder

150 mm, 6"
1235154



1/1

1235155-1

150 mm, 6"



1/1

1235155-2

185 mm, 7 1/4"



1/1

1235155-3

200 mm, 8"

MAYO-HEGAR

GD-4191

Needle holder medium
fine patterns

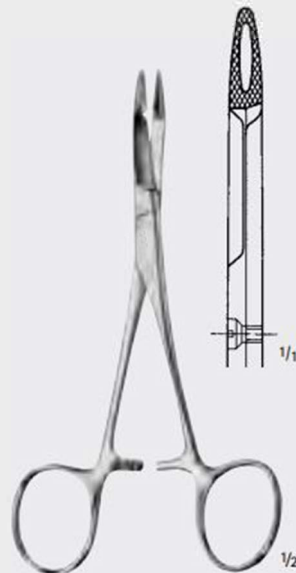

1/1

HEGAR-OLSEN

GD-4192

Needle holders with scissors

140 mm, 5 1/2"

1235156

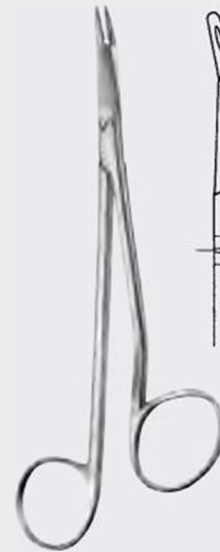

1/1

GILLIES

GD-4193

Needle holder with scissors

150 mm, 6"

1235157



1/2



$\frac{1}{2}$

1235158-1

140 mm, 5 $\frac{1}{2}$ "



$\frac{1}{2}$

1235158-2

170 mm, 6 $\frac{3}{4}$ "



$\frac{1}{2}$

1235158-3

200 mm, 8"

MATHIEU

GD-4194 

Needle holder



$\frac{1}{2}$

$\frac{1}{2}$

CRILE

GD-4195

Needle holder

150 mm, 6"
1235159



$\frac{1}{2}$

$\frac{1}{2}$

TOENNIS

GD-4196

Needle holder, elastic pattern

180 mm, 7"
1235160



For holding tissue and membranes. The slit in the working tip serves for precise positioning of the needle.

GD-4197

Suture forceps, angulated

150 mm, 6"

1235161



CASTROMEJO

GD-4198

DUROGRIP[®] Needle holder

145 mm, 5 3/4"

1235162



GD-4199

DUROGRIP[®] Needle holder

180 mm, 6 3/4"

1235163



GD-4200

DUROGRIP[®] Needle holder

180 mm, 7"

1235164

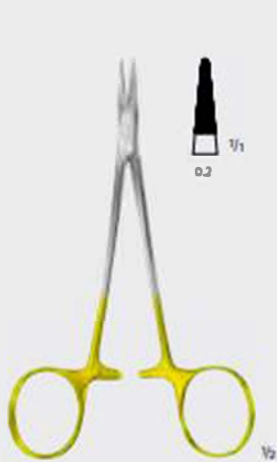

CONVERSE
GD-4201
very delicate
130 mm, 5 1/8"
1235165



HALSEY
GD-4202
130 mm, 5 1/8"
1235166



BABY-CRILE-WOOD
GD-4203
150 mm, 6"
1235167

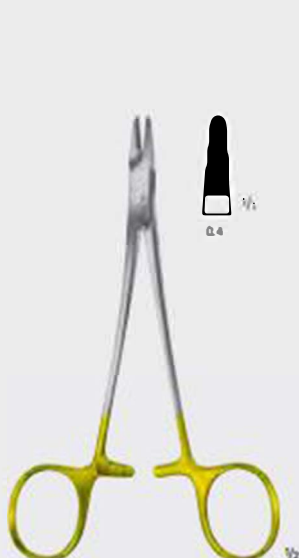

CRILE-WOOD
GD-4204
145 mm, 5 3/4"
1235168

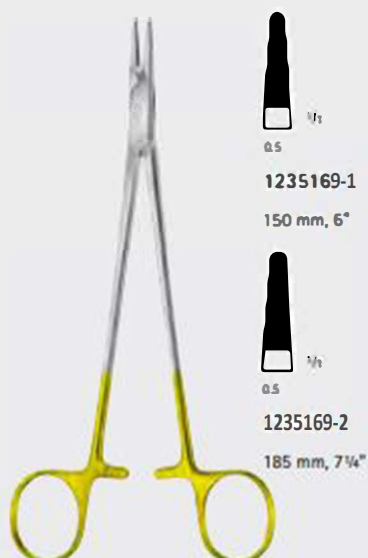

HEGAR-MAYO
GD-4205

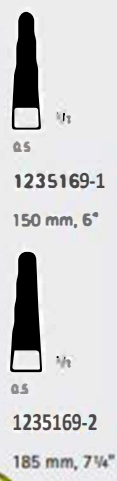

SAROT
GD-4206
175 mm, 7"
1235170



DE BAKEY
GD-4207
very delicate



1235171-1
165 mm, 6 1/2°



1235171-2
210 mm, 8 1/4°



1235171-3
165 mm, 6 1/2°



1235171-4
210 mm, 8 1/4°



DE BAKEY
GD-4208



1235172-1
150 mm, 6°



1235172-2
180 mm, 7°



RYDER
GD-4209
very delicate



1235173-1
135 mm, 5 1/2°



1235173-2
155 mm, 6°



1235173-3
175 mm, 7°

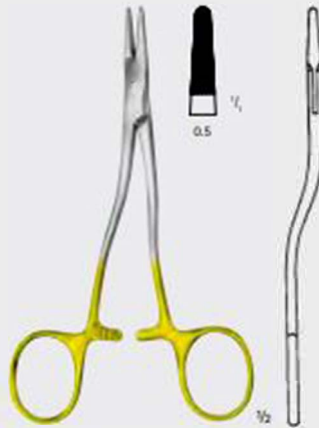

KILNER
GD-4210
135 mm, 5 1/4°
1235174

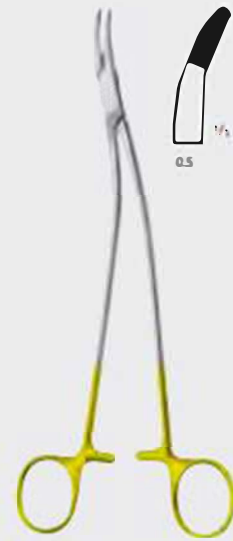

STRATTE
GD-4211
210 mm, 8 1/4°
1235175





GD-4212

With smooth jaws

125 mm, 5°
1235176

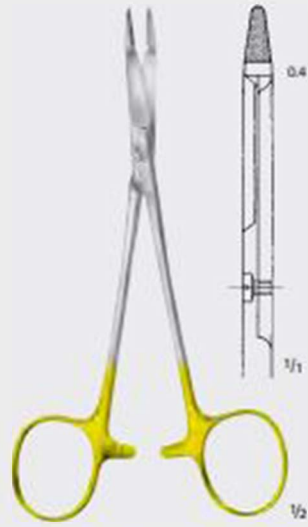

HEGAR-OLSEN modif. LAN

GD-4213

145 mm, 5 3/4°
1235177



HEGAR-OLSEN

GD-4214

165 mm, 6 1/2°
1235178

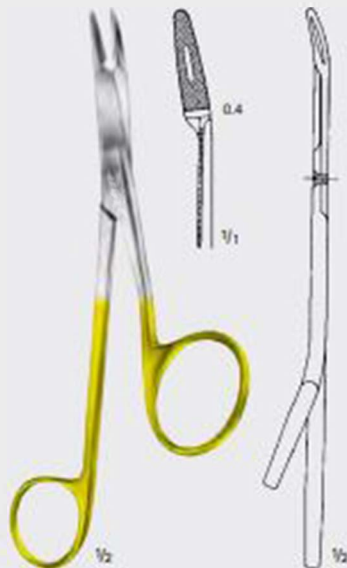

GILLIES

GD-4215

160 mm, 6 1/4°
1235179



TOENNIS

GD-4216

Elastic pattern

180 mm, 7°

1235180



GD-4217

200 mm, 8°

1235181



LANGENBECK

GD-4218

200 mm, 8°

1235182



1235183-1 1235183-2 1235183-3
140 mm, 170 mm, 200 mm,
5 1/2" 6 3/4" 8"

MATHIEU

8M GD-4219

DUROGRIP[®] Needle holder, delicate pattern



1235184-1 1235184-2 1235184-3
140 mm, 170 mm, 200 mm,
5 1/2" 6 3/4" 8"

MATHIEU-STANDARD

GD-4220 M

DUROGRIP[®] Needle holder



LICHTENBERG

GD-4221

DUROGRIP[®] Needle holder, elastic pattern

195 mm, 7 3/4"

1235185



HÖSEL

GD-4222

DUROGRIP[®] Needle holder with long neck

205 mm, 8"

1235186



GD-4223 70 x 53 x 9 mm

Needle case

1235187



GD-4224 150 x 90 x 10 mm

Need case

1235188



1235189-1 50 x 25 x 5 mm

1235189-2 50 x 30 x 6 mm

1235189-3 75 x 25 x 5 mm

Needle case

GD-4225



1235190-1 65 x 13 mm

1235190-2 95 x 16 mm

Needle case complete,
with interior box

GD-4226

BL929R

-

Exterior box only,
non perforated



1235191-1 62 x 11 mm

1235191-2 90 x 14 mm

Interior box only,
perforated

GD-4227



BOWMAN GD-4228

1235192-1	0.7 + 0.8 mm Ø, Fig. 00/0
1235192-2	0.9 + 1.1 mm Ø, Fig. 1/2
1235192-3	1.3 + 1.4 mm Ø, Fig. 3/4
1235192-4	1.5 + 1.6 mm Ø, Fig. 5/6
1235192-5	1.8 + 1.9 mm Ø, Fig. 7/8

German silver
Probes, malleable
130 mm, 5 1/8"



diam. of tips	Length		
	1 mm	1,5 mm	2 mm
-		1235193-1	130 mm, 5 1/8"
		1235193-2	145 mm, 5 3/4"
		1235193-3	160 mm, 6 1/4"

GD-4229

BN104R - BN136R

Probes



1/2

**HAUER
GD-4230**

Medicine applicator
135 mm, 5 1/4"
1235194



1/2

**STIEGLITZ
GD-4231**

Splinter forceps
140 mm, 5 1/2"



1/4

1235195-1



1/4

1235195-2



1/2

GD-4232

Nerve instrument
for broken nerve instrument
130 mm, 5 1/8"
1235196



1/2

GD-4233

Nerve instrument
for broken nerve instrument
125 mm, 5"
1235197



1/2

GD-4234

Pin holding forceps
with lock
150 mm, 6"
1235198



diam.		
2 mm	1235197-1	1235198-1
3 mm	1235197-2	1235198-2
4 mm	1235197-3	1235198-3
5 mm	1235197-4	1235198-4
	140 mm, 5 1/2"	170 mm, 6 3/4"

ADSON
GD-4235
 with finger cut-off
 190 mm, 7 1/2"
 1235199

ADSON
GD-4236
 5.0 mm diam., tip 6.5 mm wide,
 with LUER hub
 180 mm, 7"
 1235200



PLESTER

GD-4237

1235201-1	Ø 1.5 mm
1235201-2	Ø 2.0 mm
1235201-3	Ø 2.5 mm
1235201-4	Ø 3.0 mm

With finger cut-off and stylet,
thumb piece parallel to curve, with LUER hub
195 mm, 7 3/4"

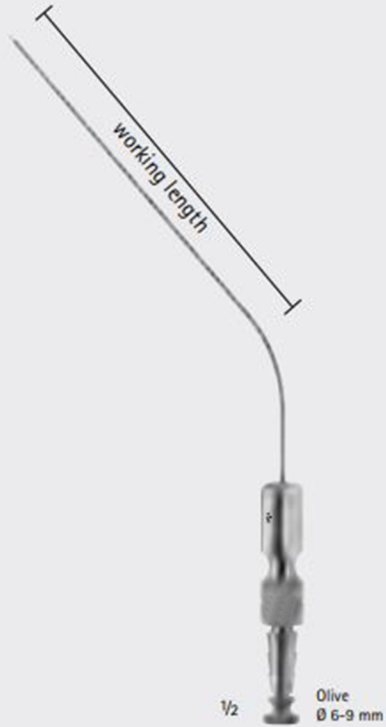

FERGUSON

GD-4238

Ø/diam.	Working length 110 mm, 4 3/8"	Working length 130 mm, 5 1/8"
1.5 mm	1235202-1	
2 mm	1235202-2	
2.5 mm	1235202-3	
3 mm	1235202-4	
4 mm	1235202-5	
5 mm	1235202-5	

With finger cut-off and stylet, thumb piece 90° to curve, with
LUER hub

180 mm, 7"