

# Ghuffi instrumentos



Gynäkologie  
Gynecology  
Ginecología

33



GRAVE

Standard		
Fig. 1	75x20 mm	<b>46001-0-1</b>
Fig. 2	95x35 mm	<b>46001-0-2</b>
Fig. 3	115x35 mm	<b>46001-0-3</b>

Laser Mod		
Fig. 1	75x20 mm	<b>46001-1-1</b>
Fig. 2	95x35 mm	<b>46001-1-2</b>
Fig. 3	115x35 mm	<b>46001-1-3</b>



mit Absaugung  
 with suction  
 con succión

GRAVE

Standard		
Fig.2	95x35 mm	<b>46002-2</b>



extra klein  
 extra small  
 extra pequeño

GRAVE

76 x 12 mm	<b>46003-1</b>
------------	----------------



extra groß  
 extra large  
 extra grande

GRAVE

120 x 38 mm	<b>46004-1</b>
-------------	----------------



PEDERSON

- Fig. 1 75x13 mm **46005-1**
- Fig. 2 100x22 mm **46005-2**
- Fig. 3 120x25 mm **46005-3**



PEDERSON

100 x 31 mm **46006-1**



COLLIN

- Fig. 1 85x30 mm **46007-1**
- Fig. 2 100x35 mm **46007-2**
- Fig. 3 110x40 mm **46007-3**

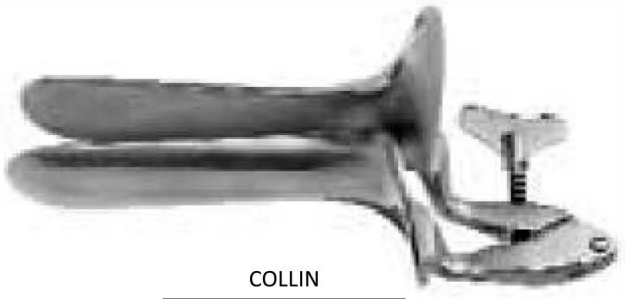

COLLIN

65x20 mm **46008-1**



COLLIN

65x10 mm **46009-1**

für Kinder  
 for children  
 para niñas



seitliche Schraube  
 lateral screw  
 tornillo lateral

CUSCO

Standard

- Fig. 0 80x24 mm **46010-0-0**  
 Fig. 1 75x32 mm **46010-0-1**  
 Fig. 2 85x35 mm **46010-0-2**  
 Fig. 3 100x35 mm **46010-0-3**

Laser Mod.

- Fig. 2 85x35 mm **46010-1-2**  
 Fig. 3 100x35 mm **46010-1-3**



CUSCO

65x20 mm **46011-1**



Mittelschraube  
 Central Screw  
 Tornillo central

CUSCO

- 80x24 mm **46012-1**  
 75x32 mm **46012-2**  
 85x36 mm **46012-3**  
 95x37 mm **46012-4**  
 110x37 mm **46012-5**  
 75x17 mm **46012-6**

flache Entenschnabelform  
 flat duck beak  
 pico de pato plano

CUSCO

- 80x32 mm **46013-1**  
 90x37 mm **46013-2**  
 115x37 mm **46013-3**



CUSCO

- Fig. 1 90x23-25 mm **46014-1**  
 Fig. 2 100x25-27 mm **46014-2**  
 Fig. 3 110x27-30 mm **46014-3**

Schweizer Modell  
 Swiss Pattern  
 Modelo suizo



FREEWAY GRAVE

100 x 32 mm **46015-1**



FREEWAY GRAVE

45° **46016-1**



TRELAT

85x33 mm **46017-1**  
95x35 mm **46017-2**  
115x43 mm **46017-3**



SEMM

90x14-18 mm **46018-1**  
100x17-20 mm **46018-2**  
100x25-30 mm **46018-3**

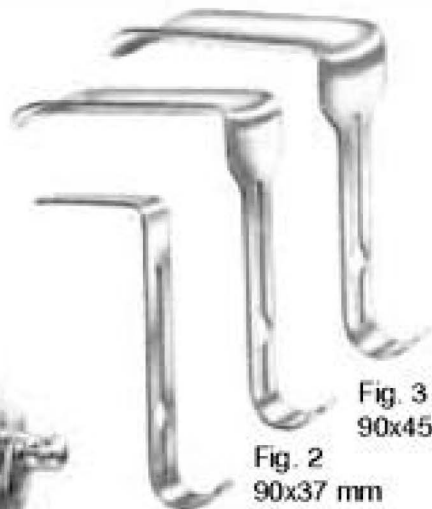
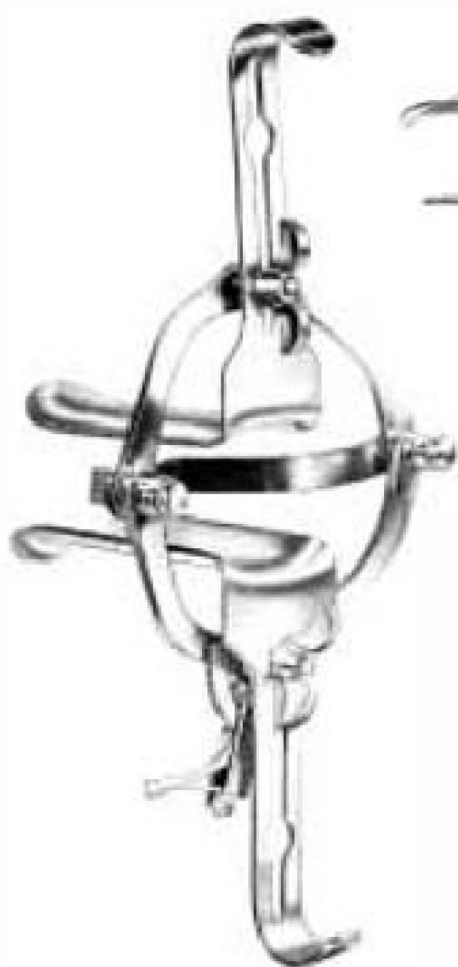

Fig. 1  
45x17 mm

Fig. 2  
90x37 mm

Fig. 3  
90x45mm

O,SULLIVAN O,CONNOR

Set compl. **46019-0**

Fig. 1  
45x17 mm **46019-1**

Fig. 2  
90x37 mm **46019-2**

Fig. 3  
90x45 mm **46019-3**

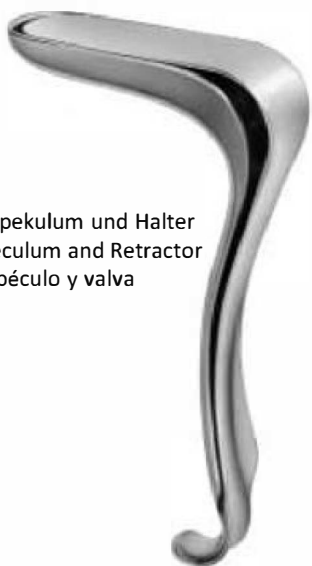

Satz aus Spekulum und Halter  
 Set of Speculum and Retractor  
 Set de espéculo y valva

KRISTELLER

- Fig.0 **46020-0**  
 Fig.1 **46020-1**  
 Fig.2 **46020-2**  
 Fig.3 **46020-3**



Spekulum  
 Speculum  
 Espéculo

KRISTELLER

- Fig.0 70x15 mm **46021-0**  
 Fig.1 70x27 mm **46021-1**  
 Fig.2 80x30 mm **46021-2**  
 Fig.3 90x36 mm **46021-3**

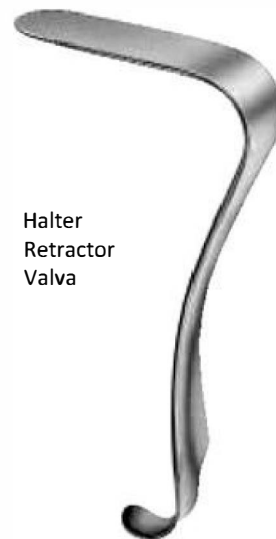

Halter  
 Retractor  
 Valva

KRISTELLER

- Fig.0 75x10 mm **46022-0**  
 Fig.1 75x23 mm **46022-1**  
 Fig.2 85x26 mm **46022-2**  
 Fig.3 100x32 mm **46022-3**

mit konischen Blättern, für Jungfrauen  
 with taper blades, for virgins  
 Con hojas cónicas, para vírgenes.



Satz aus Spekulum und Halter  
 Set of Speculum and Retractor  
 Set de espéculo y valva

KRISTELLER

- Fig.1 **46023-1**  
 Fig.2 **46023-2**



Spekulum  
 Speculum  
 Espéculo

KRISTELLER

- 105x18 mm **46024-1**  
 105x21 mm **46024-2**



Halter  
 Retractor  
 Valva

KRISTELLER

- 110x14 mm **46025-1**  
 115x17 mm **46025-2**

flache Spekula  
 Specula flat hollow  
 Base del espéculo hueca

Satz aus Spekulum und Halter  
 Set of Speculum and Retractor  
 Set de espéculo y valva



KRISTELLER

Fig.1 **46026-1**  
 Fig.2 **46026-2**  
 Fig.3 **46026-3**

Spekulum  
 Speculum  
 Espéculo

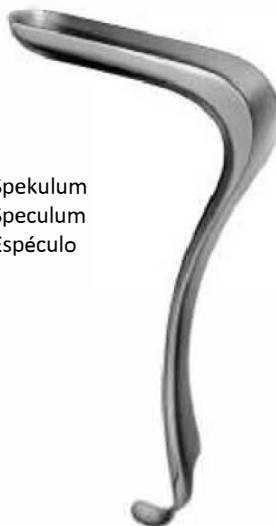

KRISTELLER

Fig.1 105 x 26 mm **46027-1**  
 Fig.2 105 x 25 mm **46027-2**  
 Fig.3 105 x 33 mm **46027-3**

Halter  
 Retractor  
 Valva



KRISTELLER

Fig.1 115 x 22 mm **46028-1**  
 Fig.2 115 x 24 mm **46028-2**  
 Fig.3 115 x 29 mm **46028-3**

Satz aus Spekulum und Halter  
 Set of Speculum and Retractor  
 Set de espéculo y valva



KRISTELLER

Fig.00 **46029-00**  
 Fig.0 **46029-0**  
 Fig.1 **46029-1**  
 Fig.2 **46029-2**  
 Fig.3 **46029-3**

Spekulum  
 Speculum  
 Espéculo



KRISTELLER

Fig.00 110x18 mm **46030-00**  
 Fig.0 110x20 mm **46030-0**  
 Fig.1 110x27 mm **46030-1**  
 Fig.2 110x30 mm **46030-2**  
 Fig.3 110x36 mm **46030-3**

Halter  
 Retractor  
 Valva

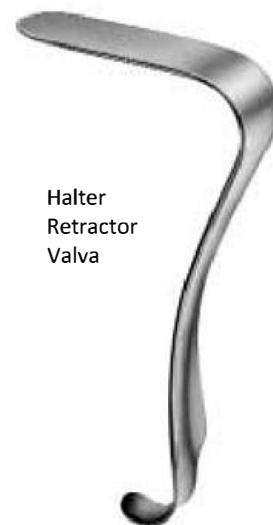

KRISTELLER

Fig.00 115x14 mm **46031-00**  
 Fig.0 115x17 mm **46031-0**  
 Fig.1 115x23 mm **46031-1**  
 Fig.2 115x26 mm **46031-2**  
 Fig.3 115x32 mm **46031-3**



für Kinder  
for children  
para niñas

Satz aus Spekulum und Halter  
Set of Speculum and Retractor  
Set de espéculo y valva

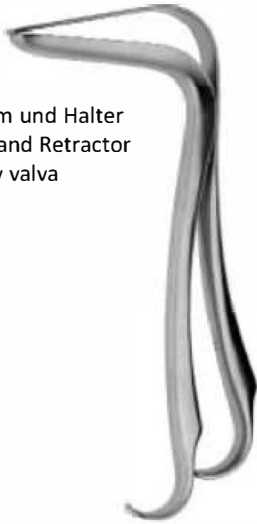

KRISTELLER

Fig.0 46032-0

Spekulum  
Speculum  
Espéculo

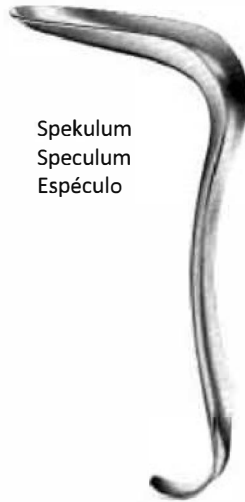

KRISTELLER

70x15 mm 46033-1

Halter  
Retractor  
Valva

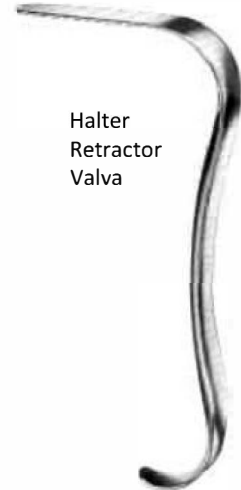

KRISTELLER

75x10 mm 46034-1

Satz aus Spekulum und Halter  
Set of Speculum and Retractor  
Set de espéculo y valva

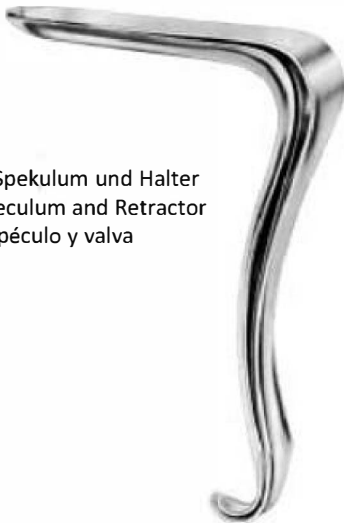

KRISTELLER

Fig.0 46035-0

Spekulum  
Speculum  
Espéculo

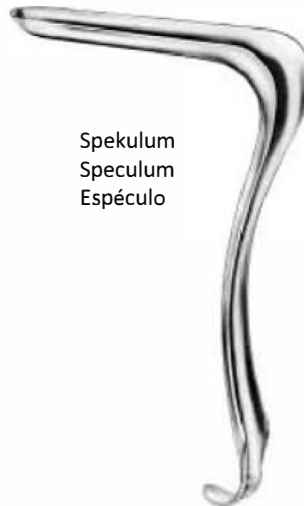

KRISTELLER

135x36 mm 46036-1

Halter  
Retractor  
Valva

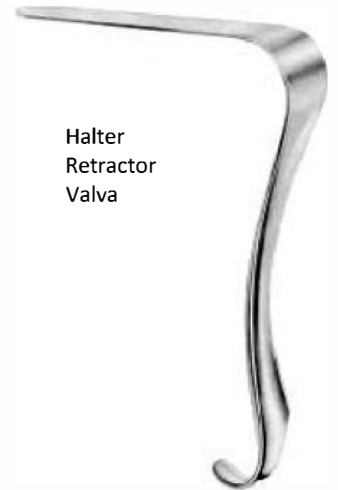

KRISTELLER

140x30 mm 46037-1



Satz aus Spekulum und Halter  
Set of Speculum and Retractor  
Set de espéculo y valva

KALLMORGEN

Fig.1 **46038-1**  
Fig.2 **46038-2**

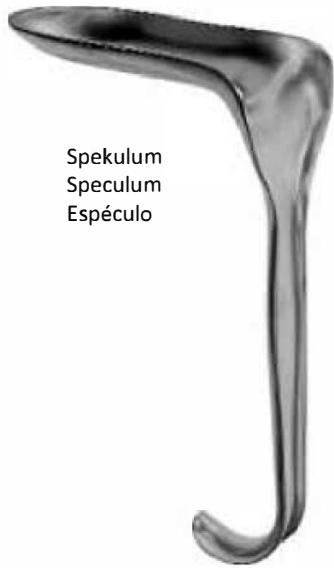

Spekulum  
Speculum  
Espéculo

KALLMORGEN

70x40 mm **46039-1**  
90x40 mm **46039-2**

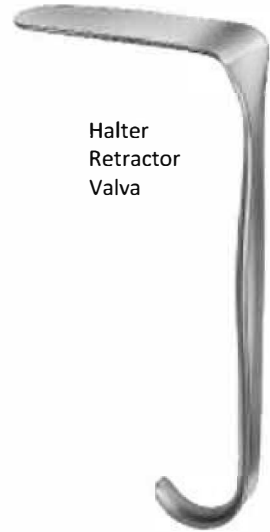

Halter  
Retractor  
Valva

KALLMORGEN

70x33 mm **46040-1**  
90x33 mm **46040-2**

56 x 13 mm



BRAUN

56x13 mm **46041-1**

60 x 10 mm



BRAUN

60 x 10 mm **46042-1**

flache Spekula  
 flat Specula  
 espéculo plano



JACKSON

75 x 40 mm **46043-1**  
 90 x 40 mm **46043-2**  
 100 x 40 mm **46043-3**

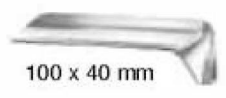
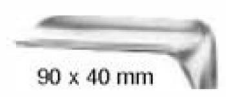
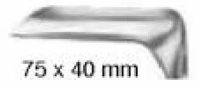

SIMS

Fig.1 70x25 mm **46044-1**  
 Fig.2 85x30 mm **46044-2**  
 Fig.3 100x40 mm **46044-3**

Scheidenspekula, doppelendig  
 Vaginal Specula, double-ended  
 Espéculo vaginal, doble extremo



SIMS

Set compl. **46045-0**

Fig.1 65x25 mm, 70x30 mm  
**46045-1**  
 Fig.2 70x30 mm, 70x35 mm  
**46045-2**  
 Fig.3 85x35 mm, 90x40 mm  
**46045-3**



DOYEN

- Fig.1 75x45 mm **46046-1**  
 Fig.2 90x45 mm **46046-2**  
 Fig.3 110x45 mm **46046-3**



leicht hohl  
 slightly concave  
 ligeramente cóncavo

DOYEN

- Fig.1 55x35 mm **46047-1-35**  
 Fig.2 75x35 mm **46047-2-35**  
 Fig.3 115x35 mm **46047-3-35**  
 Fig.1 55x45 mm **46047-1-45**  
 Fig.2 75x45 mm **46047-2-45**  
 Fig.3 115x45 mm **46047-3-45**  
 Fig.4 160x45 mm **46047-4-45**  
 Fig.1 55x60 mm **46047-1-60**  
 Fig.2 75x60 mm **46047-2-60**  
 Fig.3 115x60 mm **46047-3-60**  
 Fig.4 160x60 mm **46047-4-60**



AUVARD

83x38 mm  
 Loses Gewicht  
 Detachable Weight  
 Pesa desmontable

**46048-1**

83 x 38 mm  
 Festes Gewicht  
 Fixed Weight  
 Pesa fija

**46048-2**



BREISKY

---

100x20 mm **46049-0-20**  
100x25 mm **46049-0-25**  
100x30 mm **46049-0-30**  
100x35 mm **46049-0-35**  
100x40 mm **46049-0-40**

130x20 mm **46049-1-20**  
130x25 mm **46049-1-25**  
130x30 mm **46049-1-30**  
130x35 mm **46049-1-35**  
130x40 mm **46049-1-40**

155x40 mm **46049-2-40**



DOYEN

---

25,0 cm  
70 x 30 mm **46050-25**

Blatt allein  
Specula blade only  
Hoja de espéculo por separado



80x30 mm **46051-30**  
85x35 mm **46051-35**  
90x40 mm **46051-40**



62x40-60 mm **46052-40**  
81x45-70 mm **46052-45**

Gewicht allein  
Weight only  
Pesa por separado



10,5 cm  
400 g **46053-10**

13,0 cm  
800 g **46053-13**

Griff allein  
Handle only  
Mango por separado



20,0 cm **46054-20**

SCHERBAK ( Set )

Satz komplett mit Griff  
Gewichten (400/800g)  
und 5 Blättern

Complete set with handle  
weights (400/800g)  
and 5 blades

Set completo con mango  
peso (400/800g)  
y 5 hojas

**46055-1**



LANDAU

---

100x28 mm **46056-28**  
100x38 mm **46056-38**



WEISSBARTH

---

compl.  
80x42 mm  
**46057-1**

Auffangsieb allein  
Strainer only  
Tamiz por separado

**46057-2**

mit skalierter Sperre und Fixierschraube  
with graduated ratchet and fixing screw  
con cremallera graduada y tornillo de fijación.



FRIEDMANN

10,0 cm **46058-10**  
15,0 cm **46058-15**



KOGAN

24,5 cm **46059-24**



KOGAN

Standard  
24,0 cm **46060-0-24**

Laser  
24,0 cm **46060-1-24**





---

**HEGAR**

---

Satz mit 14 Stück (ganze Größen) von  
4,0 - 17,0 mm ohne Etui

Set of 14 pieces (full sizes)  
from 4,0 - 17,0 mm without case:

Set de 14 piezas (completo) desde  
4,0 - 17 mm sin caja:

**46061-0-14**

---

Satz mit 26 Stück (ganze Größen) von  
1,0 - 26,0 mm ohne Etui

Set of 26 pieces (full sizes)  
from 1,0 - 26,0 mm without case:

Set de 26 piezas (completo) desde  
1,0 - 26 mm sin caja:

**46046-0-26**

---

Satz mit 30 Stück (ganze Größen) von  
1,0 - 30,0 mm ohne Etui

Set of 30 pieces (full sizes)  
from 1,0 - 30,0 mm without case:

Set de 30 piezas (completo) desde  
1,0 - 30 mm sin caja:

**46046-0-30**

---

Andere Größen/Other sizes:

Satz mit 19 Stück (halbe Größen) von  
1,5-19,5 mm ohne Etui

Set of 19 pieces (half sizes)  
from 1,5 - 19,5 mm without case:

Set de 19 piezas (mitad) desde  
1,5 - 19,5 mm sin caja:

**46046-0-19**

1 mm	1,5 mm
2 mm	2,5 mm
3 mm	3,5 mm
4 mm	4,5 mm
5 mm	5,5 mm
6 mm	6,5 mm
7 mm	7,5 mm
8 mm	8,5 mm
9 mm	9,5 mm
10 mm	10,5 mm
11 mm	11,5 mm
12 mm	12,5 mm
13 mm	13,5 mm
14 mm	14,5 mm
15 mm	15,5 mm
16 mm	16,5 mm
17 mm	17,5 mm
18 mm	18,5 mm
19 mm	19,5 mm
20 mm	
21 mm	
22 mm	
23 mm	
24 mm	
25 mm	
26 mm	
27 mm	
28 mm	
29 mm	
30 mm	



---

HEGAR

14 Stück/pieces/piezas  
4,0 17,0 mm : **46062-14**

30 Stück/pieces/piezas  
1,0 -30,0 mm : **46062-30**



---

HEGAR

14 Stück/pieces/piezas  
4,0 - 17,0 mm : **46063-14**

26 Stück/pieces/piezas  
1,0 - 26,0 mm : **46063-26**



**HEGAR**

Satz mit 8 Stück von 3,0 / 4,0 -17,0 / 18,0 mm ohne Etui

Set of 8 pieces from 3,0 / 4,0 -17,0 / 18,0 mm without case:

Set de 8 piezas desde 3,0 / 4,0 -17,0 / 18,0 mm sin caja:

**46064-08**

Satz mit 13 Stück von 1,0 / 2,0 -25,0 / 26,0 mm ohne Etui

Set of 13 pieces from 1,0 / 2,0 -25,0 / 26,0 mm without case:

Set de 13 piezas desde 1,0 / 2,0 -25,0 / 26,0 mm sin caja:

**46064-13**

1/2 mm  
3/4 mm  
5/6 mm  
7/8 mm  
9/10 mm  
11/12 mm  
13/14 mm  
15/16 mm  
17/18 mm  
19/20 mm  
21/22 mm  
23/24 mm  
25/26 mm

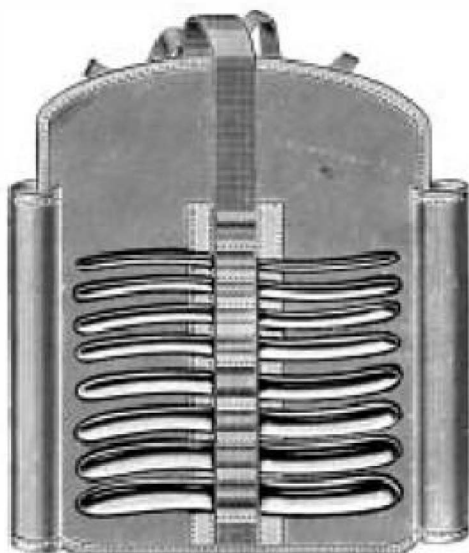

**HEGAR**

Satz mit 8 Stück von 3,0 / 4,0 -17,0 / 18,0 mm in auskochbarer Stofftasche

Set of 8 pieces from 3,0 / 4,0 -17,0 / 18,0 mm in boilable canvas roll:

Set de 8 piezas desde 3,0 / 4,0 -17,0 / 18,0 mm en funda enrollable:

**46065-8**



**HEGAR**

Satz mit 8 Stück von 3,0 / 4,0 -17,0 / 18,0 mm in Metalletui mit Scharnierdeckel

Set of 8 pieces from 3,0 / 4,0 -17,0 / 18,0 mm in metal case with hinged lid:

Set de 8 piezas desde 3,0 / 4,0 -17,0 / 18,0 mm en caja de metal con tapa abatible:

**46066-08**

Satz mit 13 Stück von 1,0 / 2,0 -25,0 / 26,0 mm in Metalletui mit Scharnierdeckel

Set of 13 pieces from 1,0 / 2,0 -25,0 / 26,0 mm in metal case with hinged lid:

Set de 13 piezas desde 1,0 / 2,0 -25,0 / 26,0 mm en caja de metal con tapa abatible:

**46066-13**



**HANK**

Fig. US.		
3,5/ 4 mm	7/ 8	<b>46067-04</b>
4,5/ 5 mm	9/10	<b>46067-05</b>
5,5/ 6 mm	11/12	<b>46067-06</b>
6,5/ 7 mm	13/14	<b>46067-07</b>
7,5/ 8 mm	15/16	<b>46067-08</b>
8,5/ 9 mm	17/18	<b>46067-09</b>
9,5/10 mm	19/20	<b>46067-10</b>
10,5/11 mm	21/22	<b>46067-11</b>
11,5/12 mm	23/24	<b>46067-12</b>
12,5/13 mm	25/26	<b>46067-13</b>

Satz mit 6 Stück von 4,5 - 10,0  
mm ohne Etui

Set of 6 pieces from 4,5 - 10,0  
mm without case:

Set de 6 piezas desde 4,5 - 10,0  
mm sin caja:

**46068-0-6**

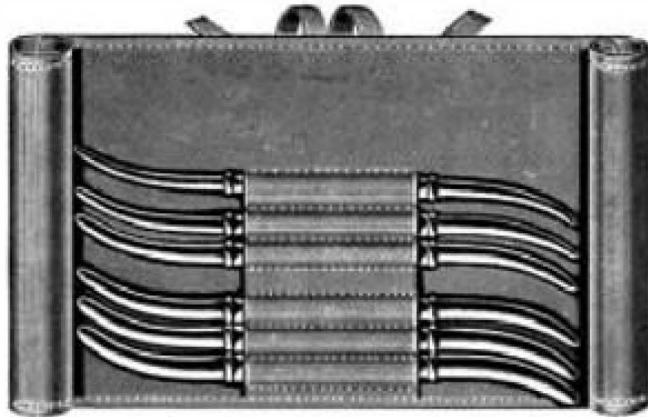

**HANK**

Satz mit 6 Stück von 4,5 - 10,0  
mm in auskochbarer Stofftasche

Set of 6 pieces from 4,5 - 10,0  
mm in boilable canvas roll:

Set de 6 piezas desde 4,5 - 10,0  
mm en funda enrollable:

**46068-1-6**



PRATT

Charr.	mm	
13/15	4,5/ 5,0 mm	<b>46069-15</b>
17/19	5,6/ 6,3 mm	<b>46069-19</b>
21/23	7,0/ 7,6 mm	<b>46069-23</b>
25/27	8,3/ 9,0 mm	<b>46069-27</b>
29/31	9,6/10,3 mm	<b>46069-31</b>
33/35	11,0/11,6 mm	<b>46069-35</b>
37/39	12,3/13,0 mm	<b>46069-39</b>
41/43	13,6/14,3 mm	<b>46069-43</b>
45/47	14,9/15,6 mm	<b>46069-47</b>
49/51	16,3/16,9 mm	<b>46069-51</b>
53/55	17,6/18,3 mm	<b>46069-55</b>
57/59	19,9/19,6 mm	<b>46069-59</b>



PRATT

Satz von 8 Stück von 4,5 / 5,0 - 13,6 / 14,3 mm  
in auskochbarer Stofftasche

Set of 8 pieces from 4,5 / 5,0 - 13,6 / 14,3 mm  
in bailable canvas roll:

Set de 8 piezas desde 4,5 / 5,0 - 13,6 / 14,3  
mm en funda enrollable:

**46070-8**



GOODELL

34,0 cm 46071-34



WYLIE

29,0 cm 46072-29

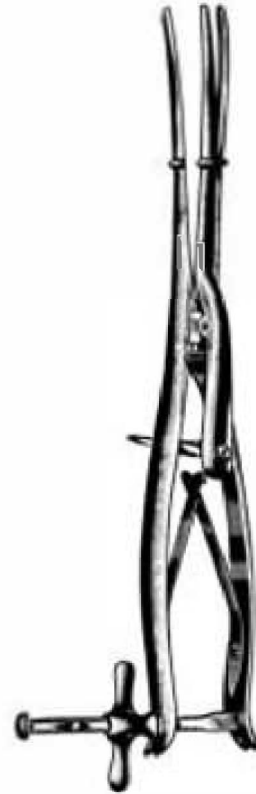

SIMS

29,0 cm 46073-29



SCHROEDER

23,0 cm **46074-23**  
25,0 cm **46074-25**



BRAUN

25,0 cm **46075-25**



SKENE

24,0 cm **46076-24**



POZZI

25,0 cm **46077-25**



DUPLAY

28,0 cm **46078-28**



STAUDE-MOORE

17,0 cm **46079-17**



COLLIN-POZZI

25,0 cm **46080-25**



BARRETT

18,0 cm **46081-18**



JARCHO

20,0 cm **46082-20**

2x2 Zähne  
 2x2 teeth  
 2x2 dientes



SCHROEDER

20,0 cm **46083-20**  
 24,0 cm **46083-24**

2x2 Zähne  
 2x2 teeth  
 2x2 dientes



SCHROEDER

24,0 cm **46084-24**



TIEMANN

22,0 cm **46085-22**





MUSEUX

24,0 cm  
 6 mm **46085-06**  
 8 mm **46085-08**  
 10 mm **46085-10**



6 mm  
 24,0 cm



8 mm  
 24,0 cm



10 mm  
 24,0 cm

2x2 Zähne  
 2x2 teeth  
 2x2 dientes



MUSEUX

24,0 cm  
 6 mm **46086-06**  
 8 mm **46086-08**  
 10 mm **46086-10**



6 mm  
 24,0 cm



8 mm  
 24,0 cm



10 mm  
 24,0 cm

2x2 Zähne  
 2x2 teeth  
 2x2 dientes



MUSEUX

20,0 cm **46088-20**

3x4 Zähne  
 3x4 teeth  
 3x4 dientes

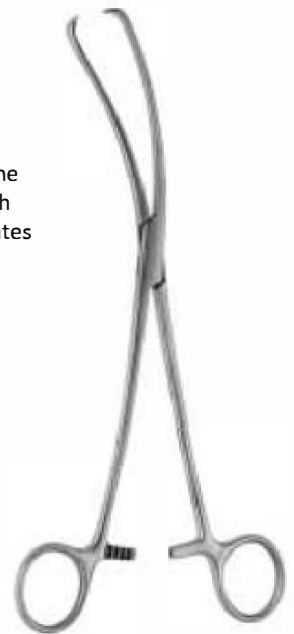

TEALE

18,0 cm **46089-18**  
 23,0 cm **46089-23**  
 26,5 cm **46089-26**

**Hakenzangen**  
**Tenaculum Forceps**  
**Pinzas para coger el cuello del útero**



2x2 Zähne  
 2x2 teeth  
 2x2 dientes

JAKOBS

21,0 cm 46090-21



2x2 Zähne  
 2x2 teeth  
 2x2 dientes

JAKOBS

21,0 cm 46091-21



2x3 Zähne  
 2x3 teeth  
 2x3 dientes

HENROTIN

20,5 cm 46092-20



4x4 Zähne  
 4x4 teeth  
 4x4 dientes

PRATT

28,0 cm 46093-28

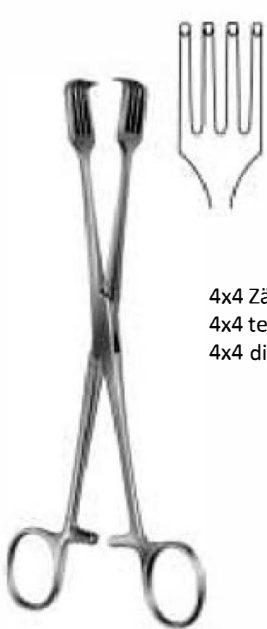

4x4 Zähne  
 4x4 teeth  
 4x4 dientes

CZERNY

21,0 cm 46094-21

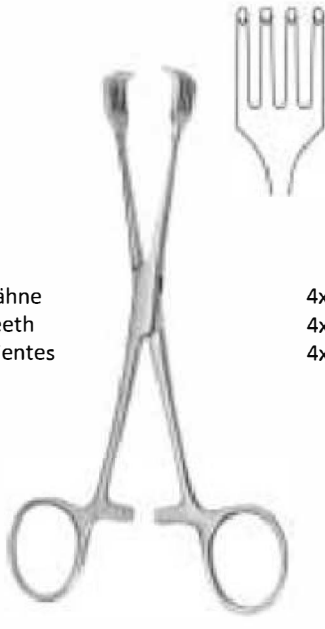

4x4 Zähne  
 4x4 teeth  
 4x4 dientes

BRAUN

15,5 cm 46095-15



5x6 Zähne  
 5x6 teeth  
 5x6 dientes

PRATT

26,0 cm 46096-26

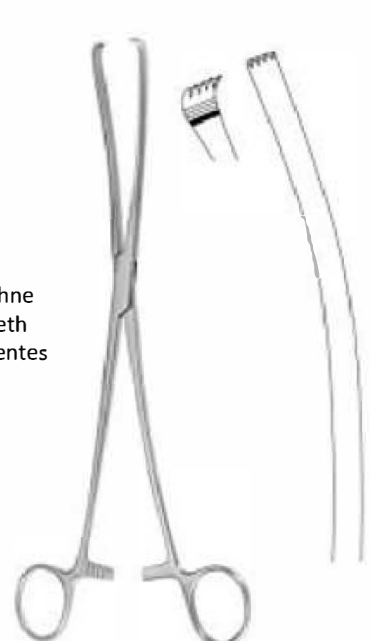

IOWA

26,0 cm 46097-26



**NOTO**

27,0 cm **46098-27**



**DOYEN**

20,0 cm **46099-20**

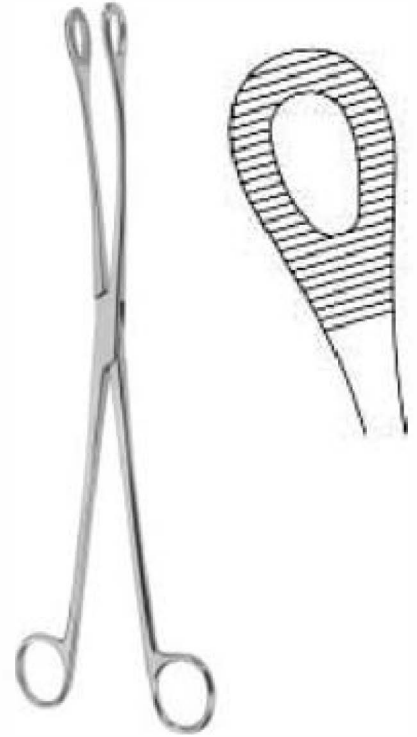

**KELLY**

32,0 cm **46100-32**

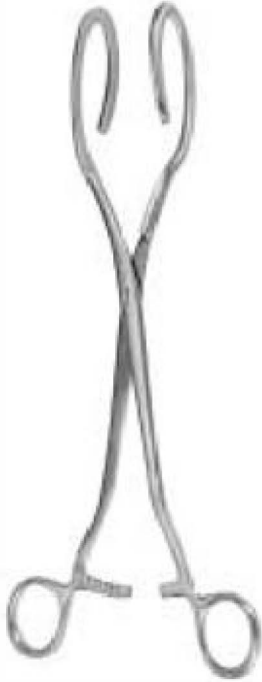

DARTIGUES

27,0 cm 46101-27



SOMER

23,0 cm 46102-23



COLLIN

25,0 cm 46103-25



COLLIN

28,0 cm 46104-28



COLLIN

25,0 cm 46105-25

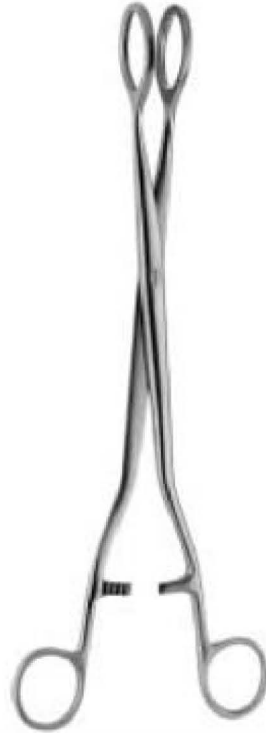

BUMM

28,0 cm 46106-28



SIEGLER HELLMANN

24,0 cm 46107-24

Amniotom  
 Amniotome  
 Amniótomo



**BEACHMANN**

26 cm **46108-26**



**BRAUN**

28 cm **46109-28**



**SIMS**

26 cm **46110-26**

Uterus-Depressoren  
 Utrine-Depressors  
 Depresores uterinos

Uterus-Sonden  
 Utrine probes  
 Sondas uterinas



**SIMS**

starr  
 rigid  
 rígido  
**46111-0-32** 32 cm



**MARTIN**

starr  
 rigid  
 rígido  
**46112-0-32** 32 cm



**COLLIN**

28 cm **46113-28**



**VALLEIX**

29,5 cm **26114-29**



RANDALL

24 cm/4 mm **46115-24**



NOVAK

1 mm **46116-1**  
2 mm **46116-2**  
3 mm **46116-3**  
4 mm **46116-4**



KEVORKIAN

30 cm

1,2 mm **46117-0-12**  
4,0 mm **46117-0-40**

mit Korb/with basket/con cesto

4,0 mm **46117-1-40**



**FAURE**

21 cm **46118-21**



**SCHUBERT**

21 cm **46119-21**  
28 cm **46119-28**



**SCHUBERT**

26 cm **46120-26**



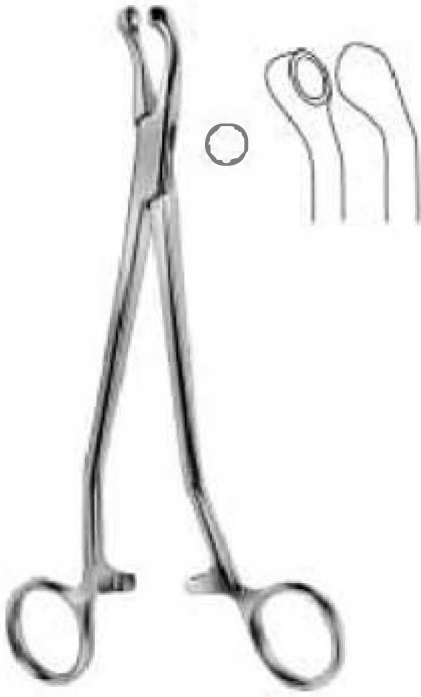

**THOMS-GAYLOR**

21,0 cm **46121-21**  
23,5 cm **46121-23**



**GELLHORN**

23 cm **46122-23**



**van DOREN**

25 cm **46123-25**

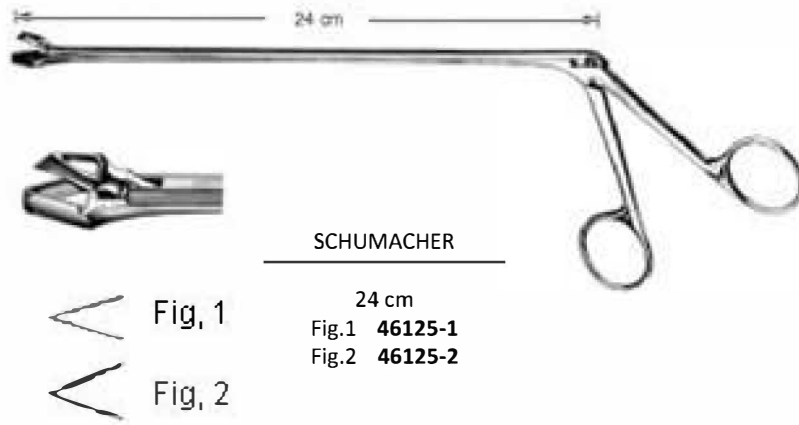
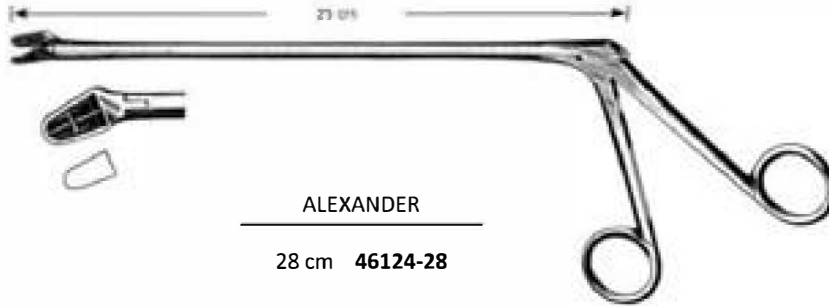

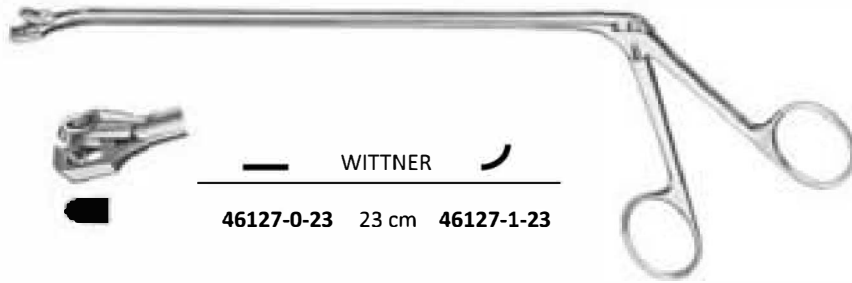

— WITTNER —  
46127-0-23 23 cm 46127-1-23



— TISCHLER-MORGAN —  
20 cm 46128-20

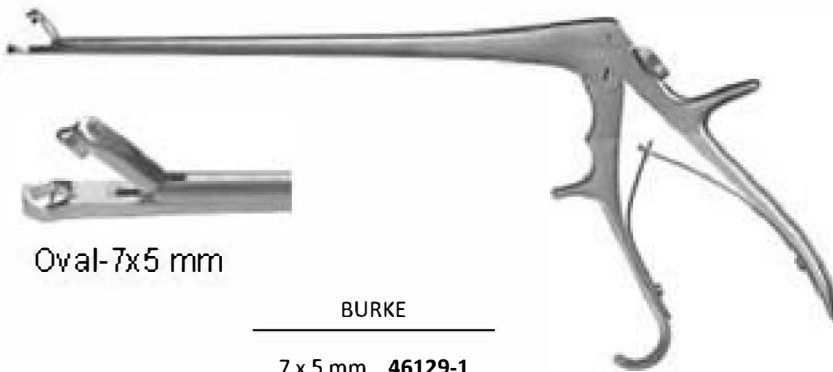

Oval-7x5 mm

— BURKE —  
7 x 5 mm 46129-1



oval ● 3,7 x 5 mm



mini



**KEVORKAN**

**TOWNSEND**

Griff allein/Handle alone/mango solo:  
**46130-0**

**Fig. 1 TISCHLER Morgan**  
**46130-1**

**Fig. 3 oval 3,7 x 5 mm**  
**46130-3**

**Fig. 5 mini**  
**46130-5**

**Fig. 4 KEVORKAN**  
**46130-4**



■ 3 x 8 mm

**KEVORKIAN-Pacific**

3 x 8 mm **46131-1**



■ 2,3 x 4,2 mm

**TOWNSEND-MINI (BABY TISCHLER)**

2,3 x 4,2 mm **46132-1**

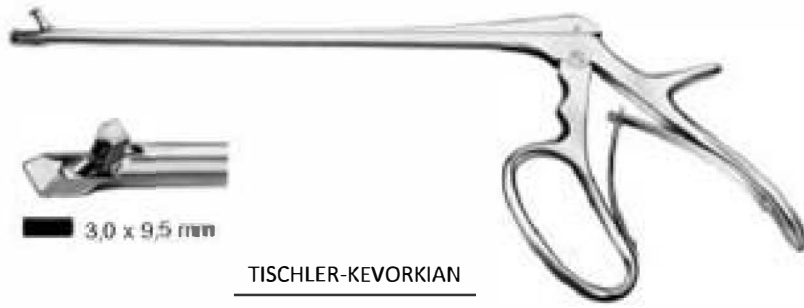

3,0 x 9,5 mm

TISCHLER-KEVORKIAN

3,0 x 9,5 mm **46133-1**



4,0 x 6,5 mm

BAGGISH

4,0 x 6,5 mm **46134-1**

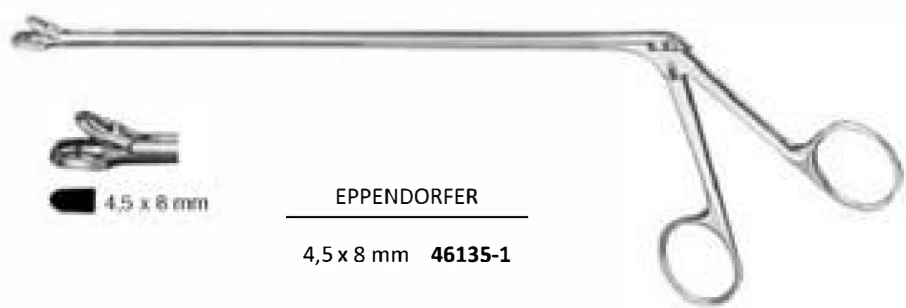

4,5 x 8 mm

EPPENDORFER

4,5 x 8 mm **46135-1**

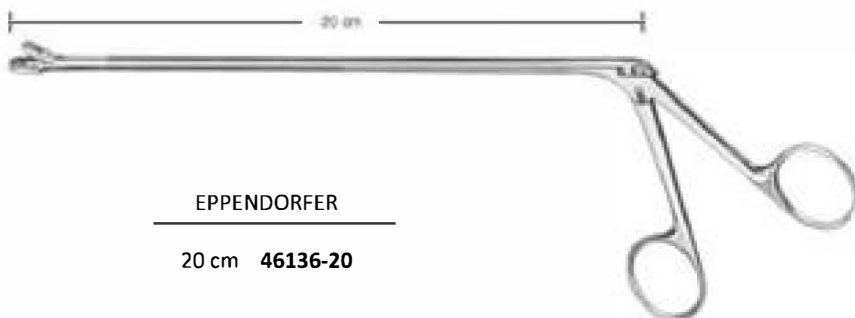

**EPPENDORFER**

20 cm **46136-20**



**TISCHLER-MORGAN**

**KEVORKIAN**

Instrument komplett  
 Complete Instrument  
 Instrumento completo:

Fig . 1 **TISCHLER-MORGAN**

**46137-0-1**

Fig .2

**46137-0-2**

Fig .3

**46137-0-3**

Fig .4 **KEVORKIAN**

**46137-0-4**

Aufsatz allein  
 Tip alone  
 Punta solo:

Fig . 1 **TISCHLER-MORGAN**

**46137-1-1**

Fig .2

**46137-1-2**

Fig .3

**46137-1-3**

Fig .4 **KEVORKIAN**

**46137-1-4**

Myom-Heber  
Myoma Screw  
Tirabuzones para fibromas



DOYEN

15 cm 46138-15

Myommesser  
Myoma Knife  
Bisturíes para fibromas



SEGOND

27 cm 46139-27

Fistelhaken  
Fistula Hooks  
Ganchos fistulares



Fig. 1



Fig. 2



Fig. 3



Fig. 4



Fig. 5

EMMET

22 cm

- Fig.1 46140-1
- Fig.2 46140-2
- Fig.3 46140-3
- Fig.4 46140-4
- Fig.5 46140-5

im Holzetui  
 in wooden case  
 en caja de madera



SCHULTZE

compl. 46141-1

ohne Manometer  
 without Manometer  
 sin manómetro



SCHULTZE

46142-1

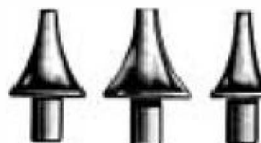

Fig.1

Fig.2

Fig.3



Manometer zu Salpingograph  
 Manometer for Salpingograph  
 Manómetro para Salpingógrafo

SCHULTZE

Fig.1 46143-1

Fig.2 46143-2

Fig.3 46143-3

Manometer 46143-4



scharf  
 sharp  
 Afilado



**SIMON**

25 cm

- Fig.1 **46144-1**
- Fig.2 **46144-2**
- Fig.3 **46144-3**
- Fig.4 **46144-4**
- Fig.5 **46144-5**
- Fig.6 **46144-6**



**SCHROEDER**

31 cm

- Fig.1 **46145-1**
- Fig.2 **46145-2**
- Fig.3 **46145-3**
- Fig.4 **46145-4**
- Fig.5 **46145-5**
- Fig.6 **46145-6**

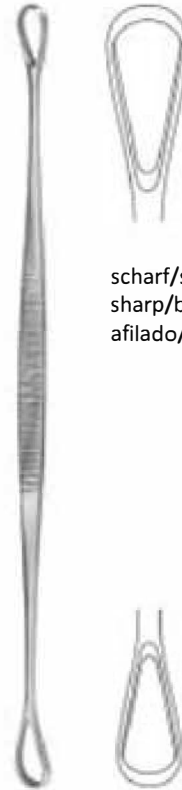

**BLAKE**

27 cm **46146-27**

scharf/stumpf  
 sharp/blunt  
 afilado/romo



**GOURDET**

28 cm

- Fig.1 **46147-1**
- Fig.2 **46147-2**
- Fig.3 **46147-3**
- Fig.4 **46147-4**
- Fig.5 **46147-5**

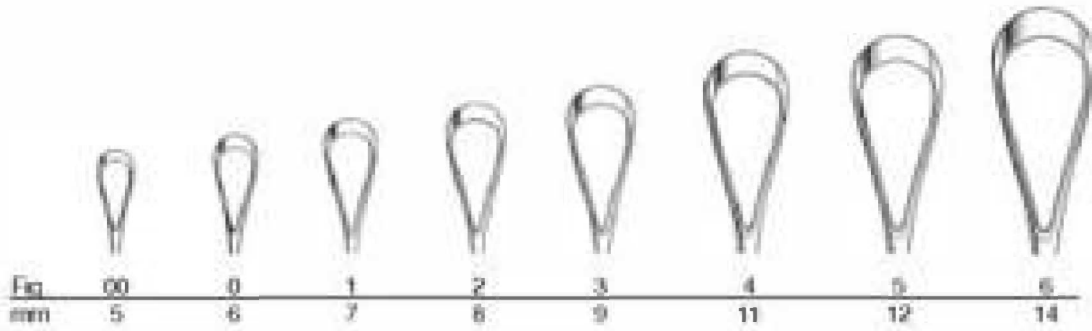

SIMS

RECAIMER

	SIMS				RECAIMER			
	A	B	C	D	A	B	C	D
Fig.00	46148-0-0-00	46148-0-1-00	46148-0-2-00	46148-0-3-00	46148-1-0-00	46148-1-1-00	46148-1-2-00	46148-1-3-00
Fig.0	46148-0-0-0	46148-0-1-0	46148-0-2-0	46148-0-3-0	46148-1-0-0	46148-1-1-0	46148-1-2-0	46148-1-3-0
Fig.1	46148-0-0-1	46148-0-1-1	46148-0-2-1	46148-0-3-1	46148-1-0-1	46148-1-1-1	46148-1-2-1	46148-1-3-1
Fig.2	46148-0-0-2	46148-0-1-2	46148-0-2-2	46148-0-3-2	46148-1-0-2	46148-1-1-2	46148-1-2-2	46148-1-3-2
Fig.3	46148-0-0-3	46148-0-1-3	46148-0-2-3	46148-0-3-3	46148-1-0-3	46148-1-1-3	46148-1-2-3	46148-1-3-3
Fig.4	46148-0-0-4	46148-0-1-4	46148-0-2-4	46148-0-3-4	46148-1-0-4	46148-1-1-4	46148-1-2-4	46148-1-3-4
Fig.5	46148-0-0-5	46148-0-1-5	46148-0-2-5	46148-0-3-5	46148-1-0-5	46148-1-1-5	46148-1-2-5	46148-1-3-5
Fig.6	46148-0-0-6	46148-0-1-6	46148-0-2-6	46148-0-3-6	46148-1-0-6	46148-1-1-6	46148-1-2-6	46148-1-3-6

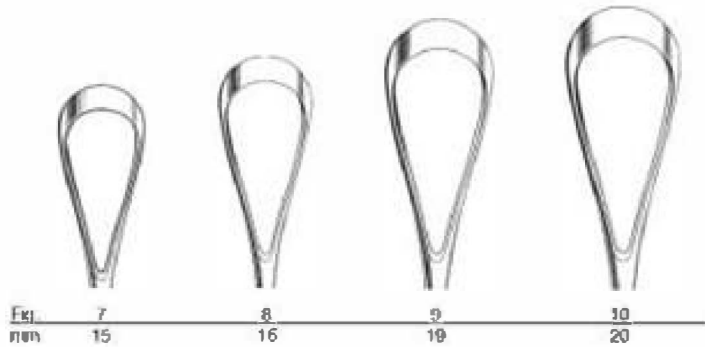

	scharf	stumpf
	sharp	blunt
	afilado	romo
fest/rigid	A	B
flex.	C	D

RECAMIER

BUMM

	RECAMIER				BUMM
	A	B	C	D	D
Fig.7	46149-0-7	46149-1-7	46149-2-7	46149-3-7	
Fig.8	46149-0-8	46149-1-8	46149-2-8	46149-3-8	
Fig.9	46149-0-9	46149-1-9	46149-2-9	46149-3-9	
Fig.10	46149-0-10	46149-1-10	46149-2-10	46149-3-10	46149-4-10

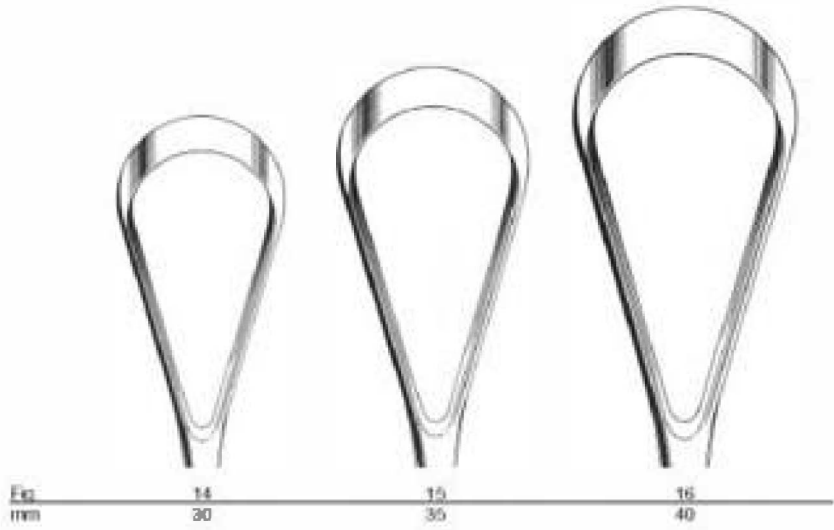

	scharf sharp afilado	stumpf blunt romo
test/rigid	A	B
flex.	C	D

	BUMM			
	A	B	C	D
Fig.14	46152-0-14	46152-1-14	46152-2-14	46152-3-14
Fig.15	46153-0-15	46153-1-15	46153-2-15	46153-3-15
Fig.16	46153-0-16	46153-1-16	46153-2-16	46153-3-16





29 cm

- Ø 3,0 mm **46154-03**
- Ø 4,0 mm **46154-04**
- Ø 6,0 mm **46154-06**
- Ø 8,0 mm **46154-08**
- Ø 10,0 mm **46154-10**
- Ø 12,0 mm **46154-12**
- Ø 14,0 mm **46154-14**



**46154-1**

Kupplungsstück  
Coupling Piece  
Pieza de acoplamiento



Tubenfaßpinzette Tubal  
seizing forceps  
Pinza para coger trompas

**NEUBÜSSER**

20 cm

- Ø 6,0 mm **46155-06**
- Ø 8,0 mm **46155-08**
- Ø 10,0 mm **46155-10**