

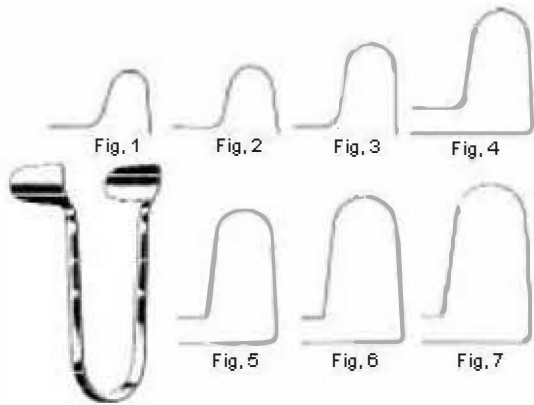

Rhinologie
Rhinology
Rinología

23



THUDICHUM

- Fig.1 **25001-1**
- Fig.2 **25001-2**
- Fig.3 **25001-3**
- Fig.4 **25001-4**
- Fig.5 **25001-5**
- Fig.6 **25001-6**
- Fig.7 **25001-7**

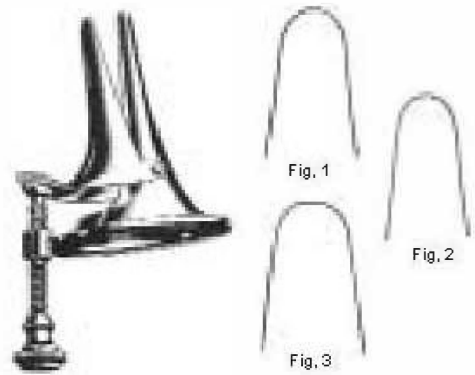

VOLTOLINI

- Fig.1 **25002-1**
- Fig.2 **25002-2**
- Fig.3 **25002-3**

leichtes Modell
 lightweight
 ligero

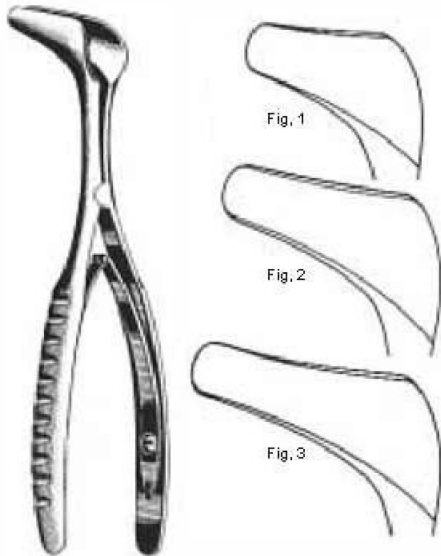

HARTMANN-HALLE

15 cm

- Fig.1 **25003-1**
- Fig.2 **25003-2**
- Fig.3 **25003-3**



Mod. Wien/Vienna/Viena

- Baby/Bebés **25004-1**
- Kind/Child/Niño **25004-2**
- Erwachsene/Adult/Adulto **25004-3**



Mod. Wien/Vienna/Viena

25005-1



TIECK-HALLE

13,5 cm **25006-13**

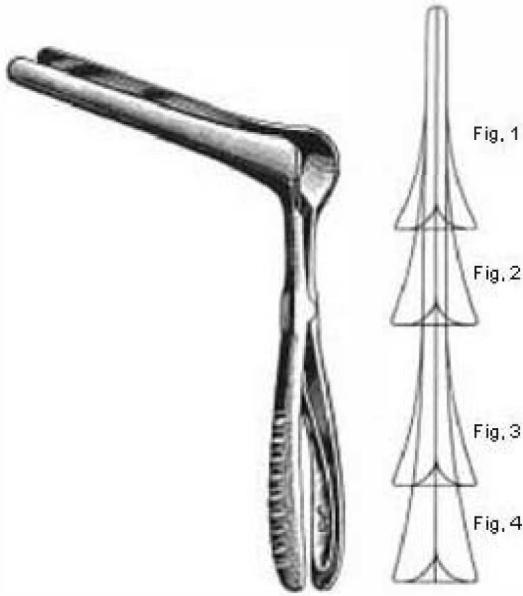

KILLIAN

13,5 cm

- Fig 1=35 mm **25007-1**
- Fig 2=50 mm **25007-2**
- Fig 3=75 mm **25007-3**
- Fig 4=90 mm **25007-4**

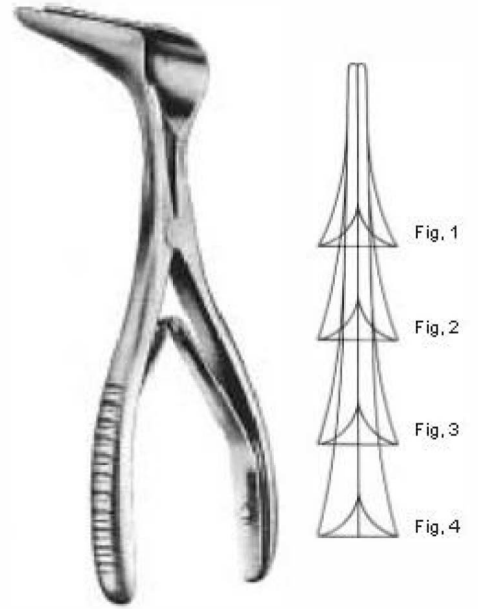

COTTLE

14 cm

- Fig.1 **25008-1**
- Fig.2 **25008-2**
- Fig.3 **25008-3**
- Fig.4 **25008-4**

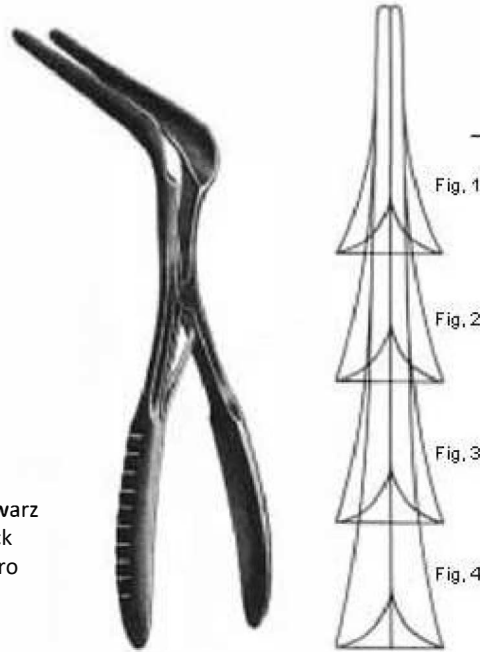

schwarz
 black
 negro

COTTLE

14 cm

- Fig.1 **25009-1**
- Fig.2 **25009-2**
- Fig.3 **25009-3**
- Fig.4 **25009-4**



YANKAUER

19 cm 25010-19

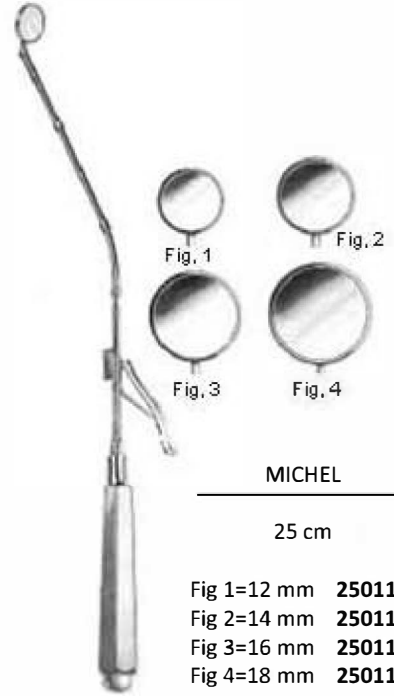

MICHEL

25 cm

Fig 1=12 mm 25011-1
Fig 2=14 mm 25011-2
Fig 3=16 mm 25011-3
Fig 4=18 mm 25011-4



TROELTSCH

15 cm 25012-15



TROELTSCH

18 cm 25013-18



JANSEN

20 cm 25014-20



HARTMANN

16 cm 25015-16



HARTMANN

20 cm 25016-20



LUBET-BARBON

20 cm 25017-20



LITTAUER

18 cm 25018-18



HEYMANN-KNIGHT

18 cm 25019-18



Fig. 1

Fig. 2

NOYES

14,5 cm

Fig.1 25020-1

Fig.2 25020-2

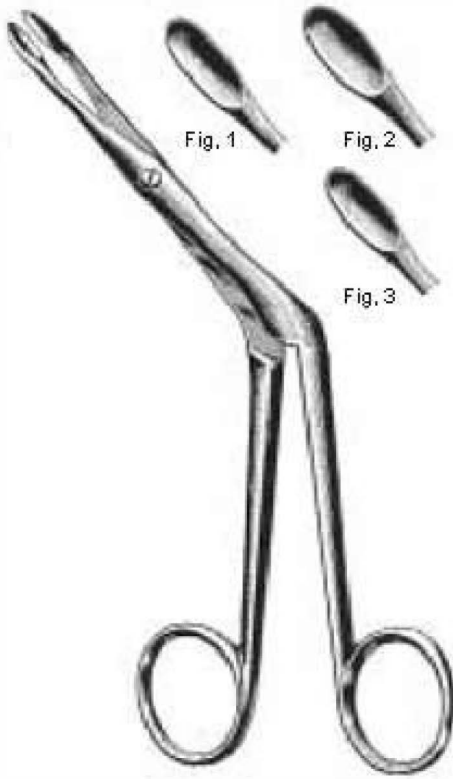

HEYMANN

18 cm

- Fig.1 25021-1
- Fig.2 25021-2
- Fig.3 25021-3



KNIGHT

18 cm 25022-18

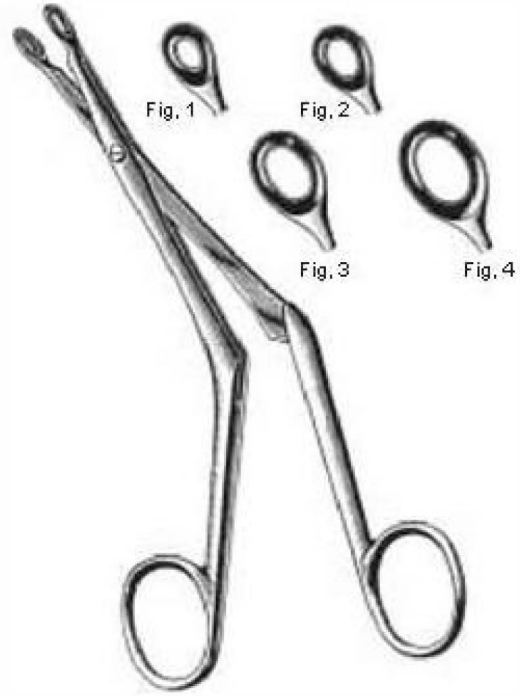

BRUENINGS

19 cm

- Fig.1 25023-1
- Fig.2 25023-2
- Fig.3 25023-3
- Fig.4 25023-4

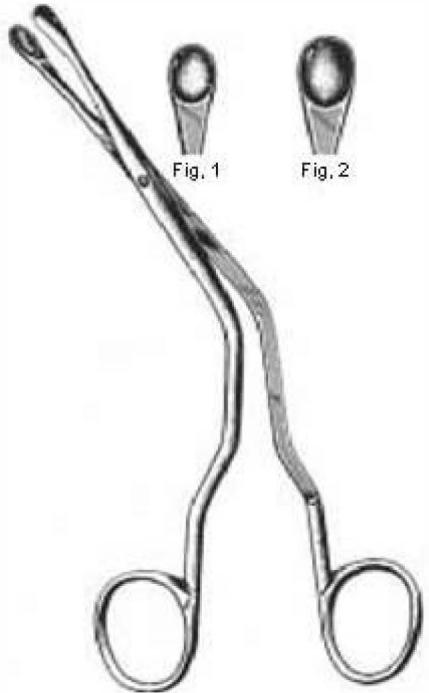

LUC
 19 cm

Fig.1 **25024-1**
 Fig.2 **25024-2**

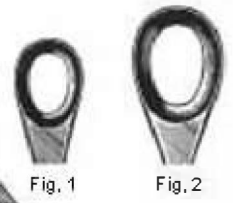
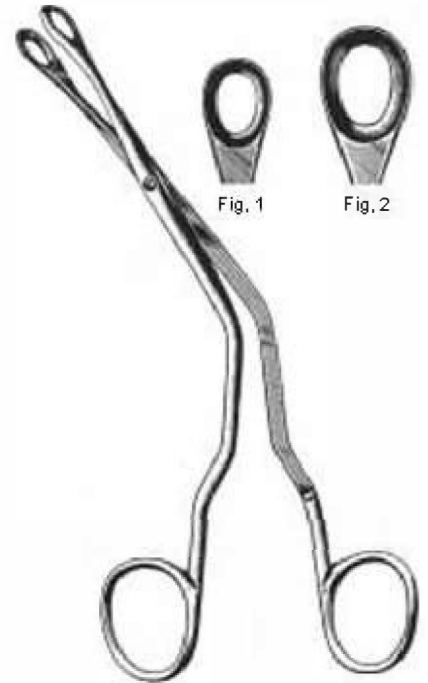

LUC
 19 cm

Fig.1 **25025-1**
 Fig.2 **25025-2**

ohne Hals / without neck/sin cuello

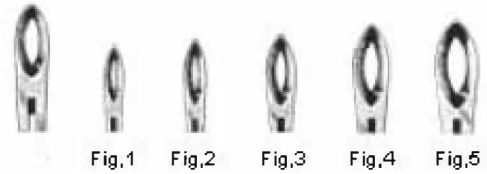

Fig.1 Fig.2 Fig.3 Fig.4 Fig.5

mit Hals / with neck/con cuello

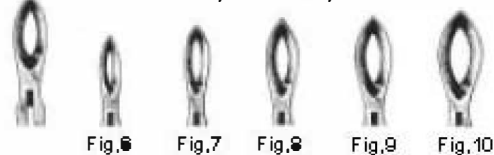
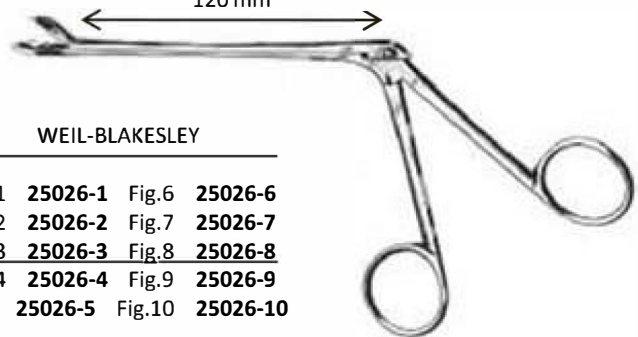

Fig.6 Fig.7 Fig.8 Fig.9 Fig.10

120 mm



WEIL-BLAKESLEY

Fig.1 **25026-1** Fig.6 **25026-6**
 Fig.2 **25026-2** Fig.7 **25026-7**
 Fig.3 **25026-3** Fig.8 **25026-8**
 Fig.4 **25026-4** Fig.9 **25026-9**
 Fig.5 **25026-5** Fig.10 **25026-10**

Scharfe Nasenzange
Nasal Cutting Forceps
Pinzas nasales de corte

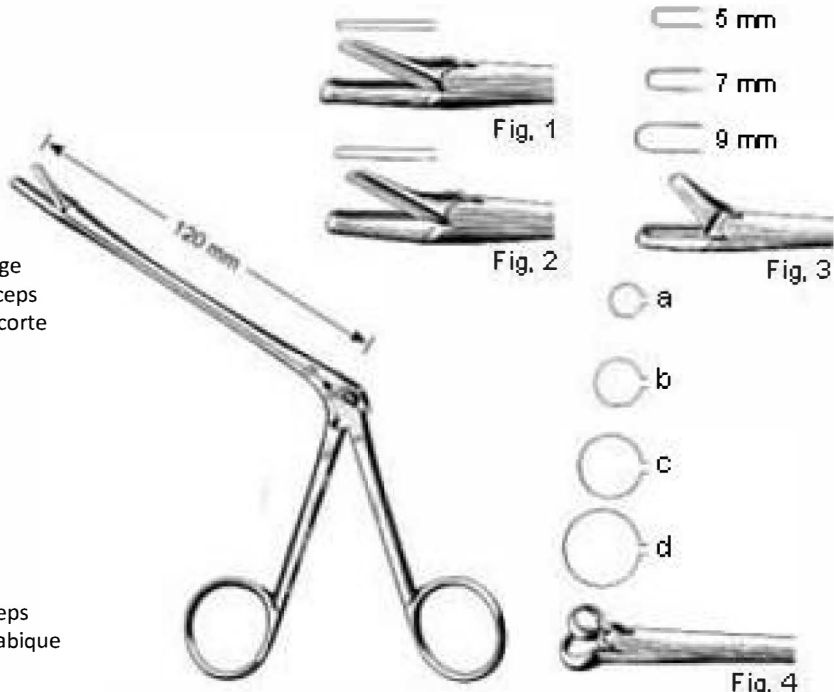

Septum-Quetschzange
Septum Crushing Forceps
Pinzas para magullar tabique



RUBIN

21 cm 25028-21

19 cm

Fig.1/STRUYCKEN
25027-1

Fig.2/STRUYCKEN
25027-2

Fig.3/MYLES
5 mm **25027-3-5**
7 mm **25027-3-7**
9 mm **25027-3-9**

Fig.4/HARTMANN
a **25027-4-1**
b **25027-4-2**
c **25027-4-3**
d **25027-4-4**

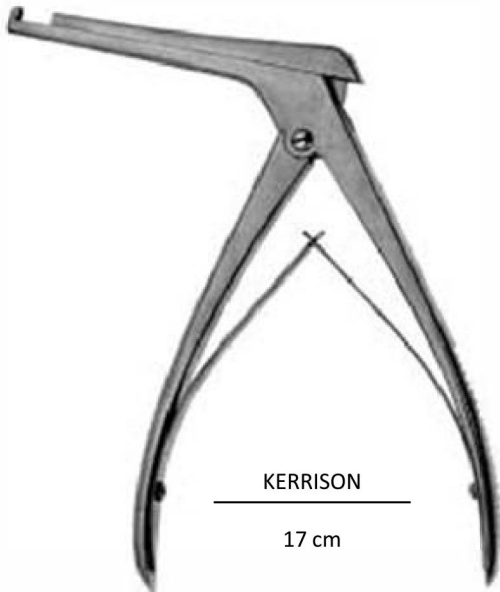

KERRISON

17 cm

mm x mm

3 x 3 **25039-3**

4 x 4 **25039-4**

5 x 5 **25039-5**

6 x 6 **25039-6**



Fig. 1



Fig. 2



HAJEK-KOFLER

3,5 mm

Fig.1 **25030-1**

Fig.2 **25030-2**



CITELLI

1,0 mm **25031-1**

2,5 mm **25031-2**

4,0 mm **25031-4**



BEYER

2,0 mm **25032-2**



HAJEK-CLAUS

20 cm **25033-20**



MIDDLETON-JANSEN

19 cm 25034-19



MIDDLETON-JANSEN

19 cm 25035-19



LICHTWITZ

10 cm

∅
1,5 mm 25036-15
1,8 mm 25036-18
2,0 mm 25036-20



KILLIAN

14 cm/3 mm ∅ 25037-14



KRAUSE

26 cm 25038-26



WILDE

24 cm 25039-24

1 Dutzend
1 dozen
1 docena



0,3 mm 25040-1

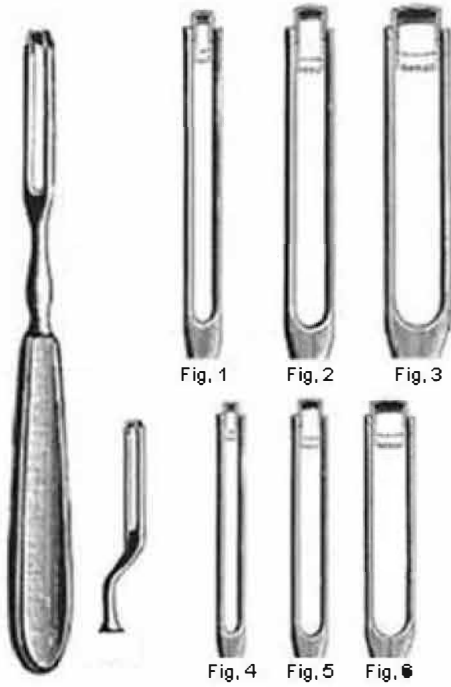

BALLENGER

20 cm

- Fig.1/3 mm **25048-1**
 Fig.2/4 mm **25048-2**
 Fig.3/5 mm **25048-3**
-
- Fig.4/3 mm **25048-4**
 Fig.5/4 mm **25048-5**
 Fig.6/5 mm **25048-6**



BRUENINGS

16,5 cm **25049-16**

Septum-Elevatorien
 Septum Elevators
 Elevadores para tabique nasal

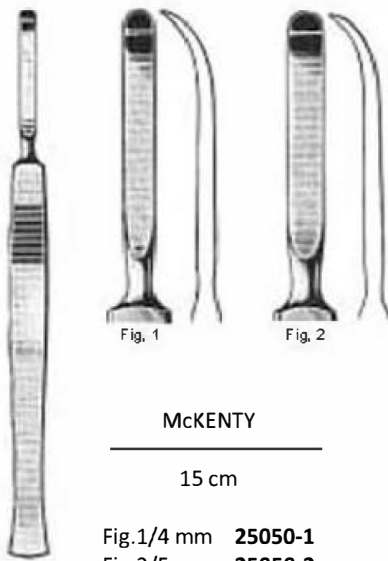

McKENTY

15 cm

- Fig.1/4 mm **25050-1**
 Fig.2/5 mm **25050-2**



ROGER

19 cm **25051-19**



FREER

18 cm **25052-18**



FREER

19 cm **25053-19**



FREER

19 cm **25054-19**



COTTLE

23 cm 25055-23



COTTLE

22 cm 25056-22



JOSEPH

16 cm 25057-16



COTTLE

19 cm 25058-19



KILLIAN

22 cm 25059-22



HAJEK-BALLENGER

22 cm 25060-22



BALLENGER

22 cm 25061-22



FREER

4 mm 25062-4



FREER

4 mm 25063-4

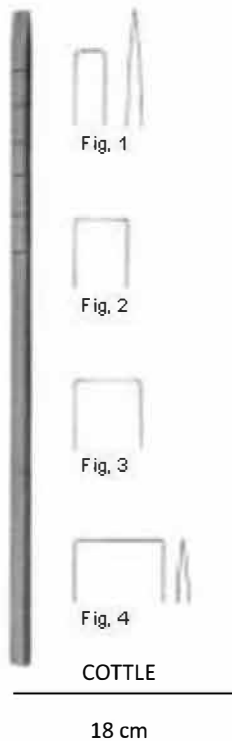

COTTLE
 18 cm
 Fig.1/4 mm **25064-1**
 Fig.2/7 mm **25064-2**
 Fig.3/9 mm **25064-3**
 Fig.4/12 mm **25064-4**



COTTLE
 18 cm/6 mm **25065-6**

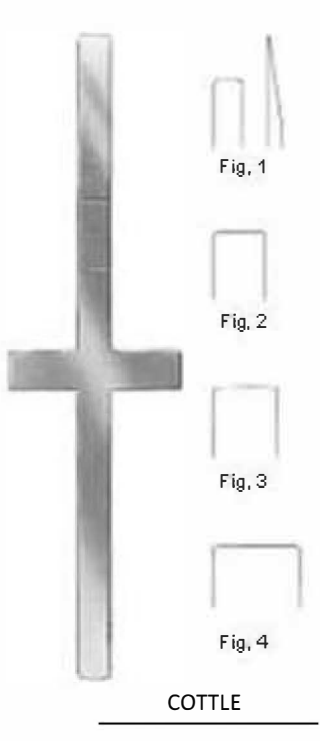

COTTLE
 18 cm
 Fig.1/4 mm **25066-1**
 Fig.2/7 mm **25066-2**
 Fig.3/9 mm **25066-3**
 Fig.4/12 mm **25066-4**



COTTLE
 18 cm
 4 mm **25067-04**
 7 mm **25067-07**
 12 mm **25067-12**

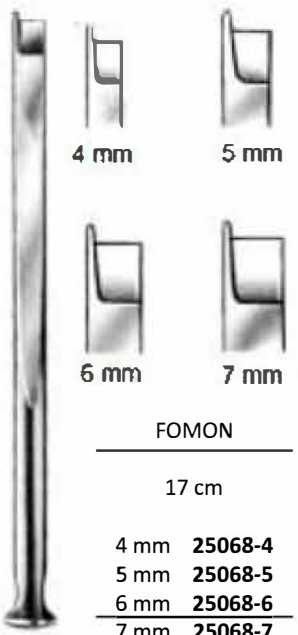

FOMON
 17 cm
 4 mm **25068-4**
 5 mm **25068-5**
 6 mm **25068-6**
 7 mm **25068-7**

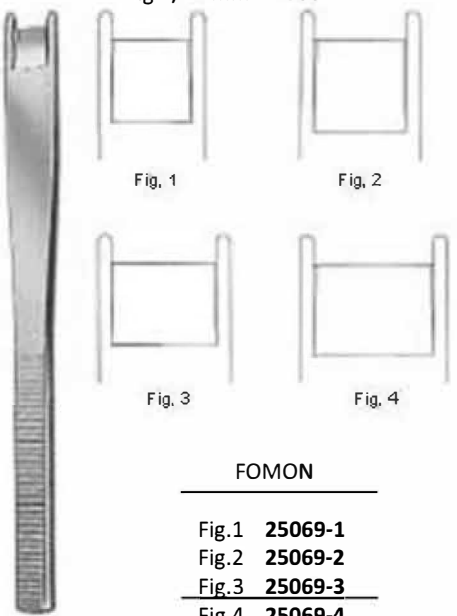

FOMON
 Fig.1 **25069-1**
 Fig.2 **25069-2**
 Fig.3 **25069-3**
 Fig.4 **25069-4**

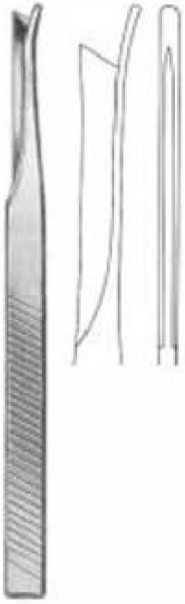

SILVER

18 cm 25070-18

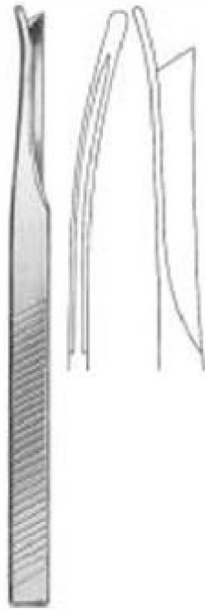

SILVER

18 cm 25071-18

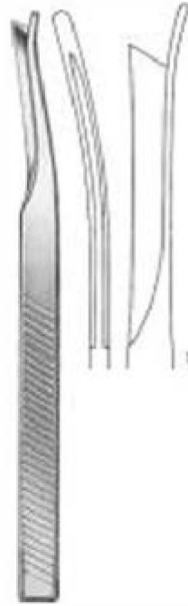

SILVER

18 cm 25072-18



KILLIAN-CLAUS

17 cm/5 mm 25073-17



HAJEK

4 mm 25074-4
6 mm 25074-6
8 mm 25074-8



WEST

16 cm 25075-16



WEST

16 cm 25076-16



FREER

6 mm 25077-6



JOSEPH

16 cm 25078-16



MALTZ

18 cm 25079-18

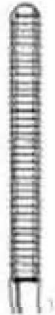
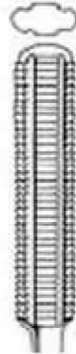

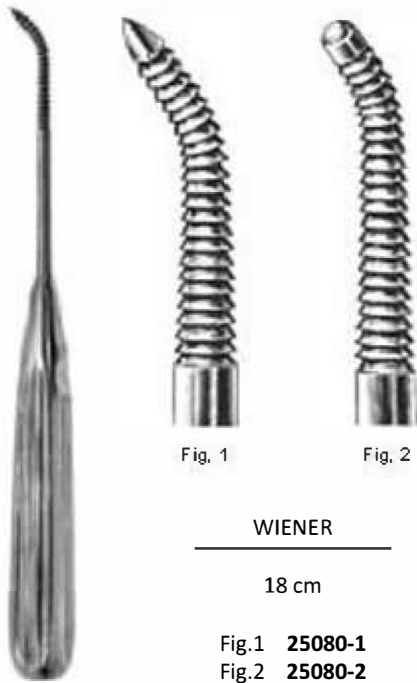

Fig. 1
Fig. 2

WIENER

18 cm

Fig.1 **25080-1**
Fig.2 **25080-2**

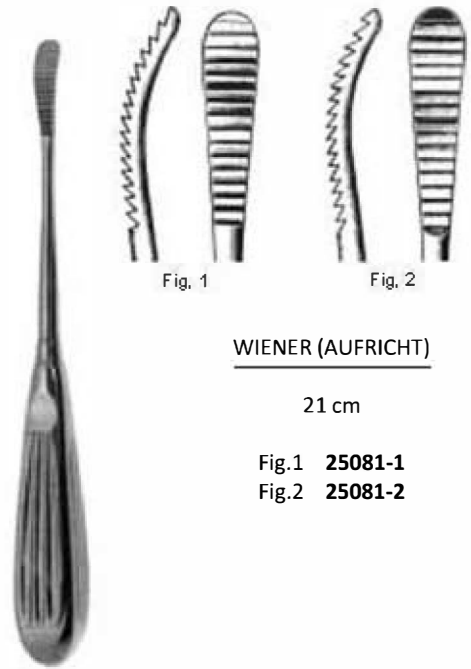

Fig. 1
Fig. 2

WIENER (AUFRICHT)

21 cm

Fig.1 **25081-1**
Fig.2 **25081-2**

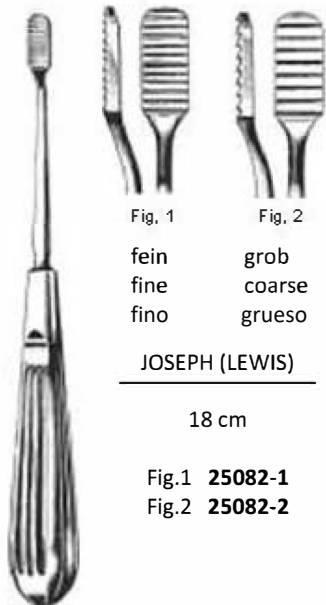

Fig. 1
Fig. 2

fein
fine
fino

grob
coarse
grueso

JOSEPH (LEWIS)

18 cm

Fig.1 **25082-1**
Fig.2 **25082-2**



MALTZ (COTTLE)

21 cm **25083-21**

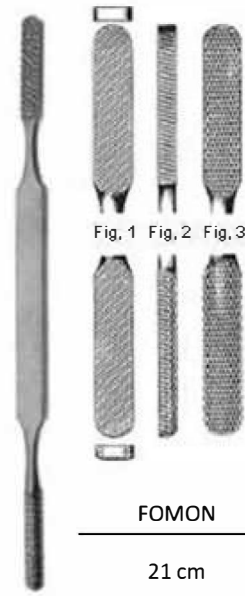

Fig. 1
Fig. 2
Fig. 3

FOMON

21 cm

Fig.1 **25084-1**
Fig.2 **25084-2**
Fig.3 **25084-3**

FOMON

20 cm TC

- Fig.1/2 **25085-1**
- Fig.3/4 **25085-3**
- Fig.5/6 **25085-5**
- Fig.7/8 **25085-7**
- Fig.9/10 **25085-9**

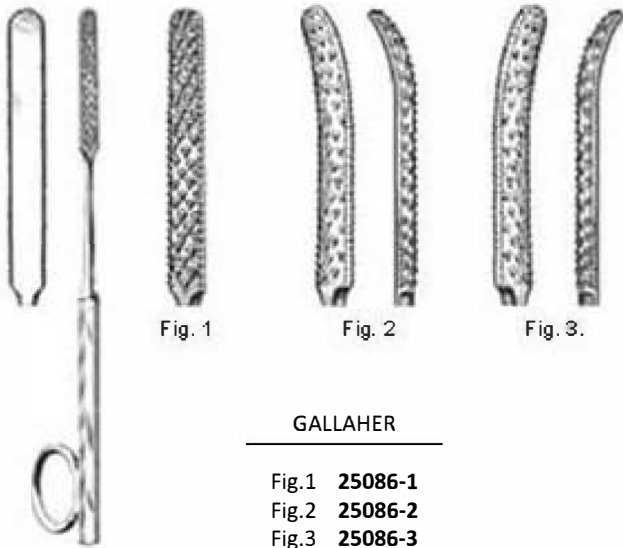
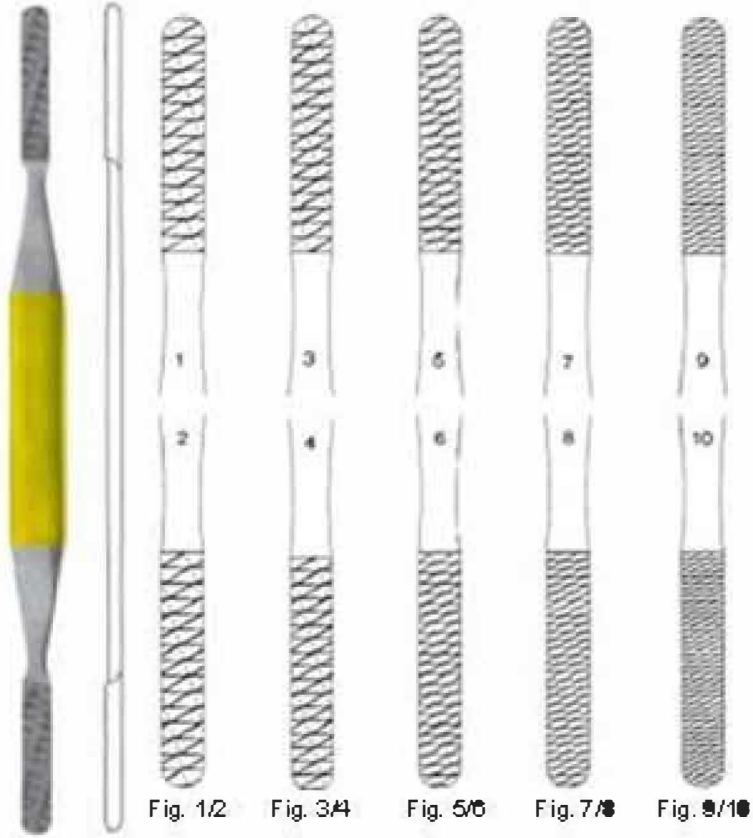

GALLAHER

- Fig.1 **25086-1**
- Fig.2 **25086-2**
- Fig.3 **25086-3**

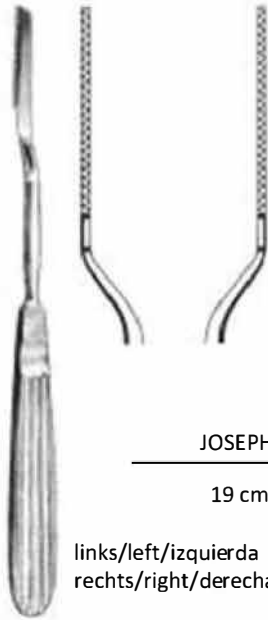

JOSEPH

19 cm

links/left/izquierda **25087-1**
rechts/right/derecha **25087-2**



JOSEPH

17 cm



AUFRICHT

19 cm **25089-19**

links/left/izquierda **25088-1**
rechts/right/derecha **25088-2**

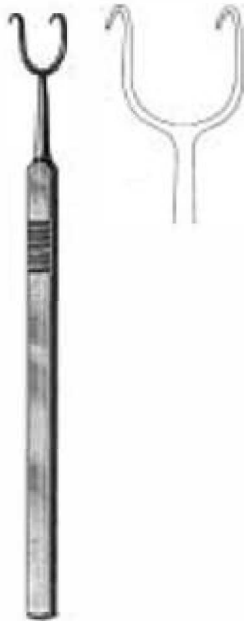

COTTLE

25090-1



FOMON

25091-1



FOMON

25092-1



COTTLE-NEIVERT

25093-1



GILLIES

18 cm
Fig.1 **25094-1**
Fig.2 **25094-2**



ASCH

23 cm 25095-23

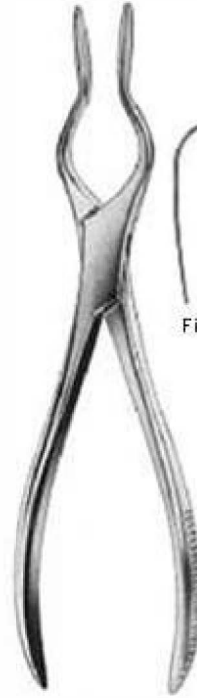

Fig. 1

Fig. 2

Fig. 3

WALSHAM

23 cm

Fig. 1 gerade/straight/recto **25096-1**

Fig. 2 links/left/izquierda **25096-2**

Fig. 3 rechts/right/derecha **25096-3**



JATHO

25097-1



FAULKNER

21 cm 25098-21



Fig. 1

Fig. 2

Fig. 3

Fig. 4

Fig. 5

Fig. 6

COAKLEY

17 cm

Fig. 1 **25099-1**

Fig. 2 **25099-2**

Fig. 3 **25099-3**

Fig. 4 **25099-4**

Fig. 5 **25099-5**

Fig. 6 **25099-6**

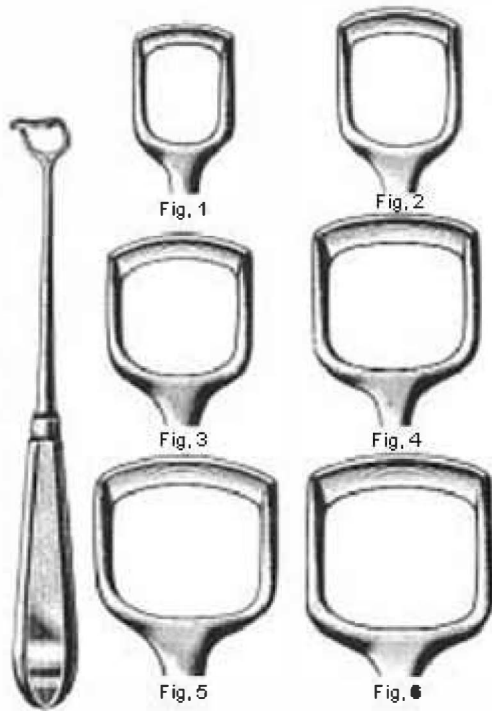

BECKMANN

22 cm

- Fig.1 **25100-1**
Fig.2 **25100-2**
Fig.3 **25100-3**
Fig.4 **25100-4**
Fig.5 **25100-5**
Fig.6 **25100-6**

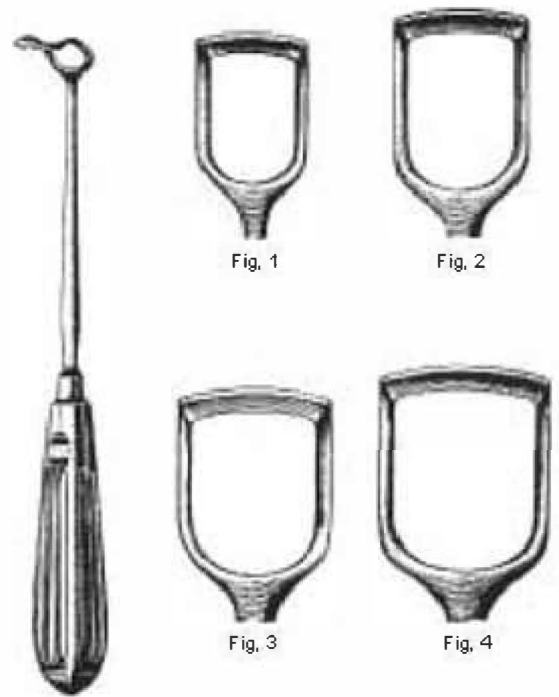

BARNHILL

21 cm

- Fig.1 **25101-1**
Fig.2 **25101-2**
Fig.3 **25101-3**
Fig.4 **25101-4**

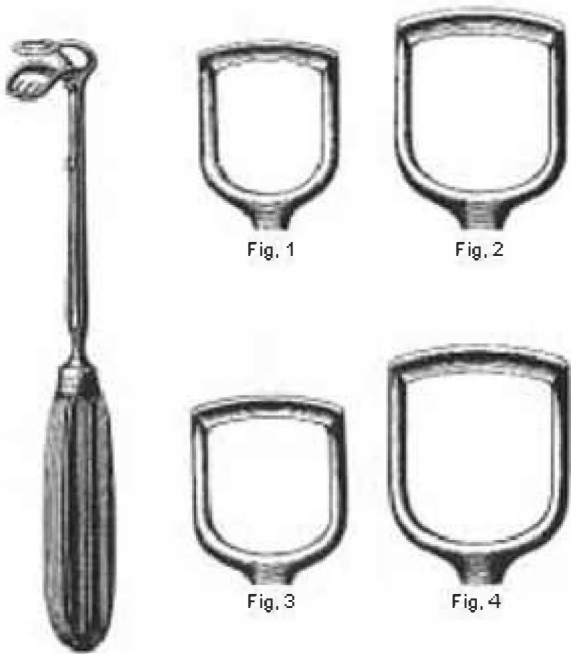

St. CLAIR-THOMSON

21 cm

- Fig. 1=12 mm **25102-1**
 Fig. 2=16 mm **25102-2**
 Fig. 3=14 mm **25102-3**
 Fig. 4=17 mm **25102-4**

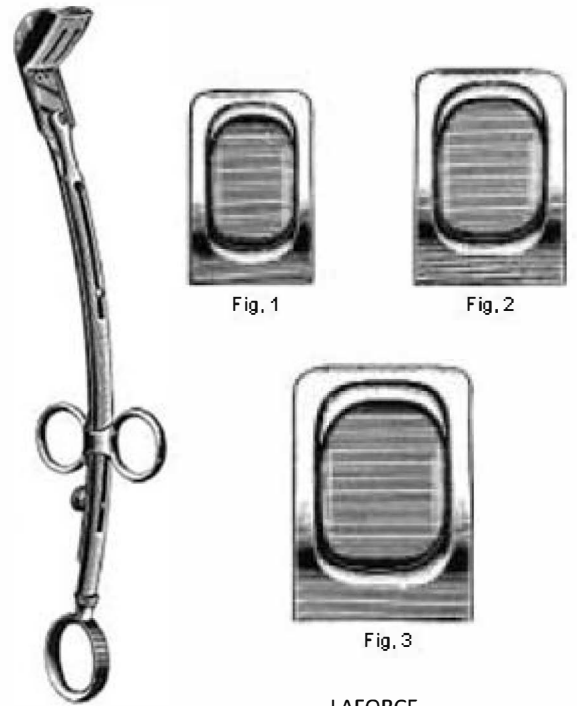

LAFORCE

LAFORCE/25 cm
25103-25

- Ersatzklingen gelocht Spare
 Blades perforated
 Cuchillas perforadas de repuesto
 Fig.1 **25103-1**
 Fig.2 **25103-2**
 Fig.3 **25103-3**