

Ghuffi
instrumentos



Atraumatische Gefäßklemmen
Atraumatic Forceps
Pinzas atraumáticas

09



— HALSTEAD-MOSQUITO —

90001-0-12 12,0 cm **90001-1-12**
90001-0-15 15,0 cm **90001-1-15**

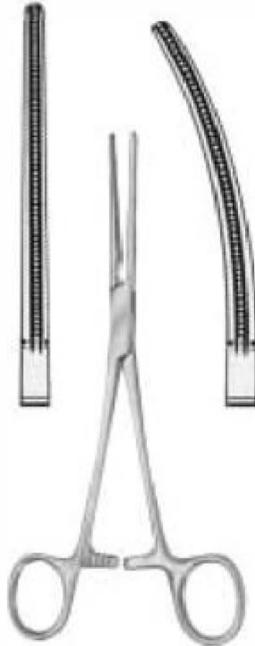

— PEAN —

90002-0-14 14,0 cm **90002-1-14**
90002-0-16 16,0 cm **90002-1-16**
90002-0-18 18,0 cm **90002-1-18**
90002-0-20 20,0 cm **90002-1-20**



— RANKIN —

90003-0-16 16,0 cm **90003-1-16**

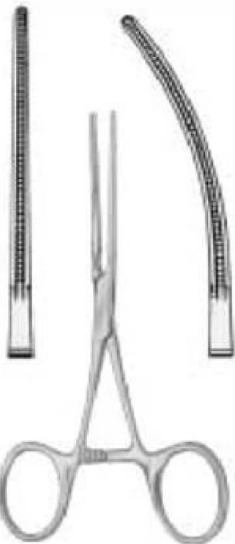

— DE BAKEY —

90004-0-12 12,0 cm **90004-1-12**



— DE BAKEY —

12,0 cm **90005-12**



— DE BAKEY —

12,0 cm **90006-12**



— DE BAKEY —

12,0 cm **90007-12**

Bronchusklemmen
Bronchus Forceps
Pinzas bronquiales



LEES

23,0 cm **90008-23**
25,0 cm **90008-25**

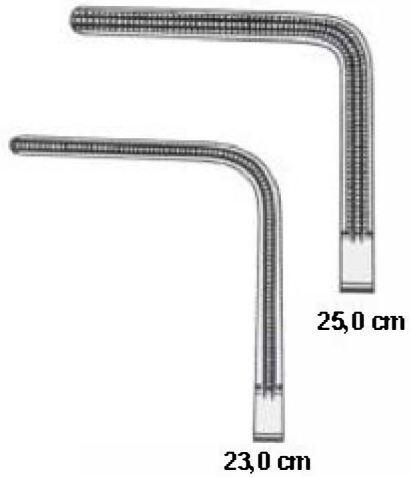

25,0 cm

23,0 cm



LEES

25,0 cm **90009-25**

Coarctationsklemmen
 Coarction Clamps
 Pinzas de coartación



POTTS

20,0 cm **90010-20**
 22,5 cm **90010-22**
 26,0 cm **90010-26**

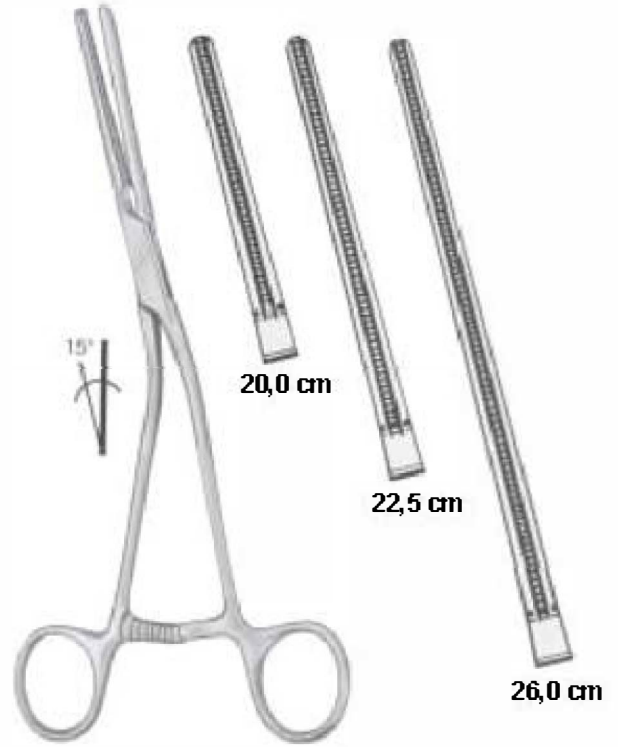

GLOVER

20,0 cm **90011-20**
 22,5 cm **90011-22**
 26,0 cm **90011-26**



POTTS / GLOVER

21,0 cm **90012-21**
24,0 cm **90012-24**



21,0 cm

24,0 cm

Anastomosenklemmen
Anastomosis Clamps
Pinza abrazadera anastomosis



GLOVER

18,0 cm **90013-18**
22,0 cm **90013-22**



18,0 cm

22,0 cm

Vascularklemme, löffelförmig
 Vascular Clamps, spoon shaped
 Pinzas vasculares, en forma de cuchara

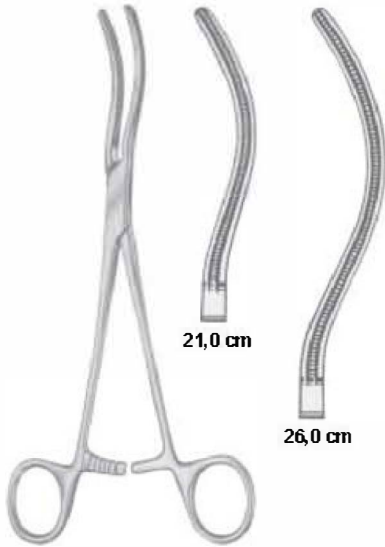

GLOVER

21,0 cm **90014-21**
 26,0 cm **90014-26**

Peripher-Vascularklemmen
 Peripheral Vascular Forceps
 Pinza vascular periférica

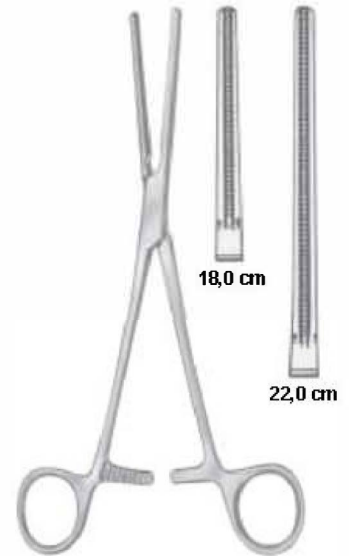

DE BAKEY

18,0 cm **90015-18**
 22,0 cm **90015-22**



DE BAKEY

18,0 cm **90016-18**
 22,0 cm **90016-22**

Atraumatische Mehrzweckklemmen
 Atraumatic Multi-Purpose Clamps
 Pinzas atraumáticas multipropósito

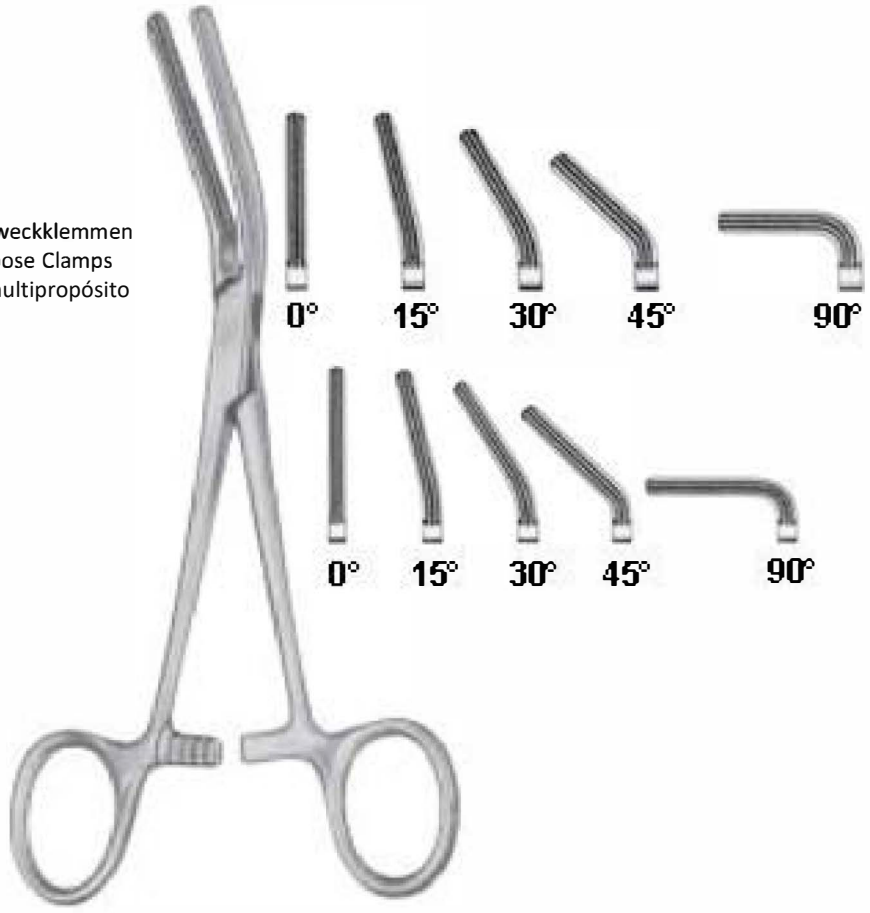

DARDIK

	0°	15°	30°	45°	90°
14 cm	-----	-----	-----	-----	90017-4-14
15 cm	90017-0-15	90017-1-15	90017-2-15	90017-3-15	-----
16 cm	-----	-----	-----	-----	90017-4-16
17 cm	90017-0-16	90017-1-17	90017-2-17	90017-3-17	-----



Peripher-Vascularklemmen
 Peripheral Vascular Forceps
 Pinza vascular periférica

LELAND-JONES
 19,0 cm **90018-19**



DE BAKEY
 26,0 cm **90019-26**



DE BAKEY
 19,0 cm **90020-19**
 20,0 cm **90020-20**



DE BAKEY
 16,0 cm **90021-16**

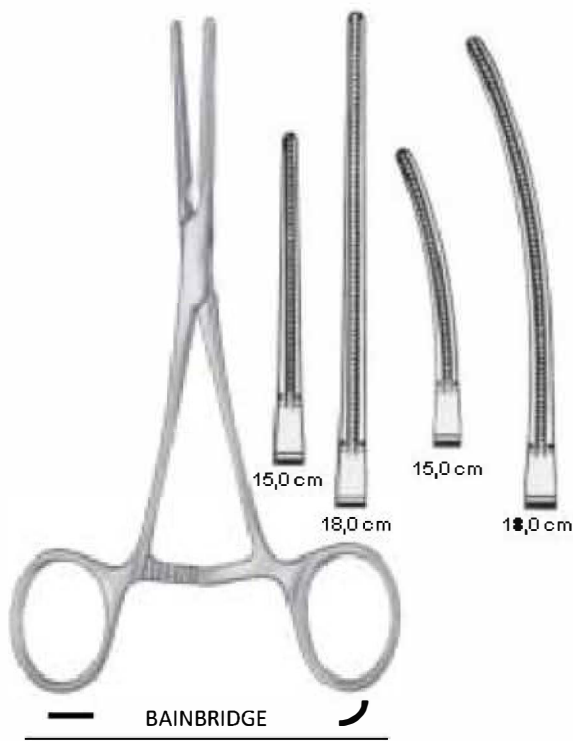

90022-0-15 15,0 cm 90022-1-15
 90022-0-18 18,0 cm 90022-1-18

Peripher-Vascularklemmen
 Peripheral Vascular Forceps
 Pinza vascular periférica



LELAND JONES
 19,0 cm 90023-19

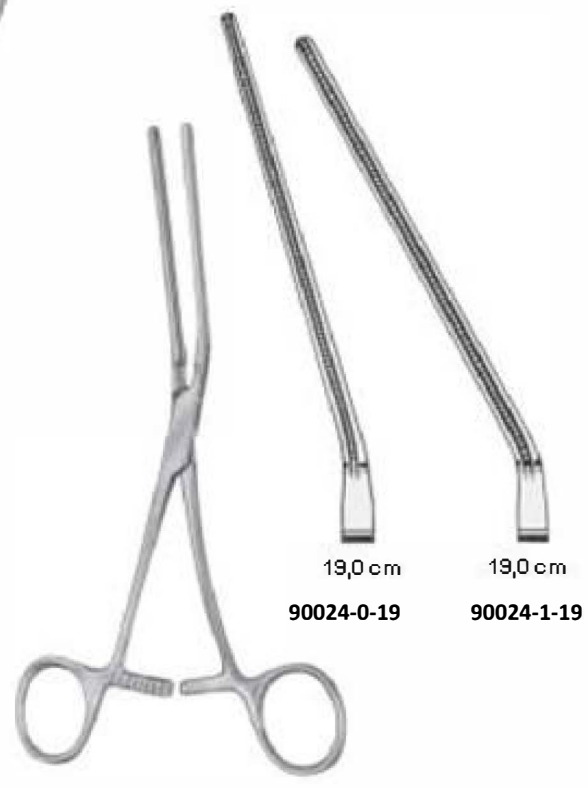

LELAND JONES
 90024-0-19 19,0 cm 90024-1-19

Aortaklemme
Aortic Clamp
Pinza abrazadera aórtica



LIDDLE

27,0 cm **90025-27**

Aorta-Anastomosenklemme Aorta-
Anastomosis Clamp
Pinza abrazadera anastomosis



LAMBERT KAY

20,0 cm **90026-20**

Iliaca-Klemme
Iliac Clamp
Pinza abrazadera ilíaca



LAMBERT KAY

20,0 cm 90027-20



DE BAKEY

20,0 cm 90028-20

links gebogen
curved to left
curvado a la izquierda



WEBER

26,0 cm 90029-26

rechts gebogen
curved to right
curvado a la derecha



WEBER

26,0 cm 90030-26

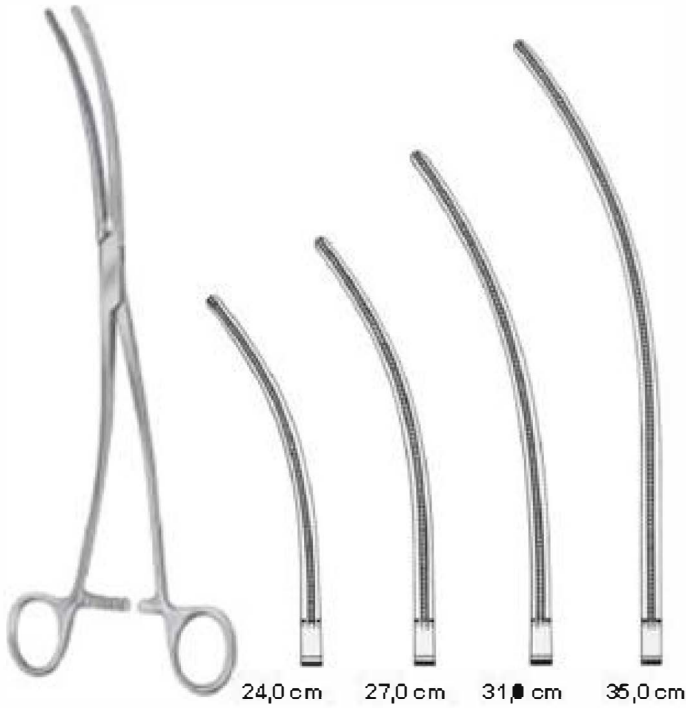

DE BAKEY

- 24,0 cm **90031-24**
- 27,0 cm **90031-27**
- 31,0 cm **90031-31**
- 35,0 cm **90031-25**

Aorta-Aneurysma Klemmen
Aorta-Aneurysm Clamps
Pinza abrazadera aórtica-aneurisma



DE BAKEY BAHNSON

- 24,0 cm **90032-24**
- 25,0 cm **90032-25**
- 26,0 cm **90032-26**



DE BAKEY

28,0 cm 90033-28

Aorta-Aneurysma Klemmen
Aorta-Aneurysm Clamps
Pinza abrazadera aórtica-aneurisma



DE BAKEY

28,0 cm 90034-28



DE BAKEY MORRIS

- 18,0 cm **90035-18**
- 20,0 cm **90035-20**
- 23,0 cm **90035-23**
- 25,0 cm **90035-25**



Atraumatische Mehrzweckklemmen
 Atraumatic Multi-Purpose Clamps
 Pinzas atraumáticas multipropósito



DE BAKEY

- 18,0 cm **90036-18**
- 21,0 cm **90036-21**
- 23,0 cm **90036-23**
- 27,0 cm **90036-27**

Aorta-Aneurysma Klemmen Aorta-
Aneurysm Clamps
Pinza abrazadera aórtica-aneurisma



DE BAKEY

25,0 cm **90037-25**
26,0 cm **90037-26**



25,0 cm

26,0 cm

Bronchusklemmen
Bronchus Forceps
Pinzas bronquiales



DE BAKEY

27,0 cm **90038-27**



DE BAKEY

20,0 cm	90039-20
24,0 cm	90039-24
25,0 cm	90039-25
30,0 cm	90039-30

Atraumatische Mehrzweckklemmen
Atraumatic Multi-Purpose Clamps
Pinzas atraumáticas multipropósito

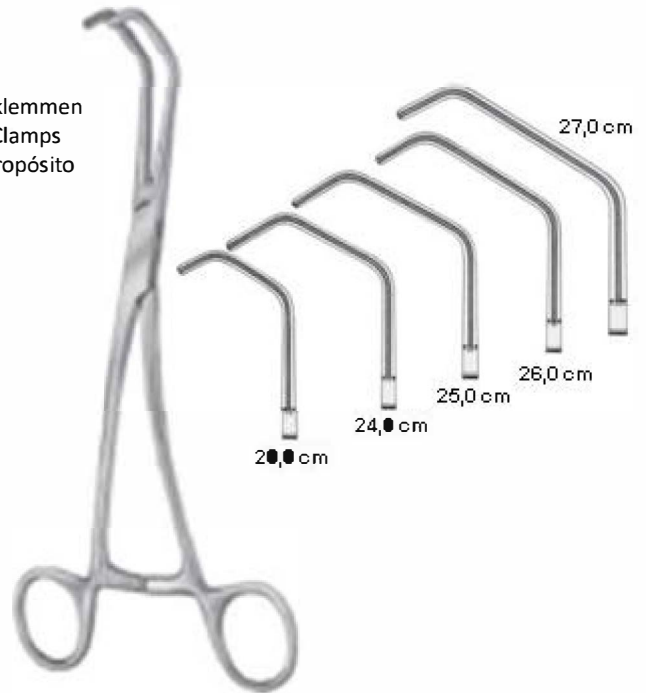

SATINSKY

20,0 cm	90040-20
24,0 cm	90040-24
25,0 cm	90040-25
26,0 cm	90040-26
27,0 cm	90040-27

Clipanlagezange
Clip Applying Forceps
Pinzas para aplicación de grapas



EDWARDS

90041-0

Clips
Grapas



EDWARDS

6 mm **90042-06**
12 mm **90042-12**



WYLIE

Fig.1 21,0 cm **90043-21**
Fig.2 22,0 cm **90043-22**

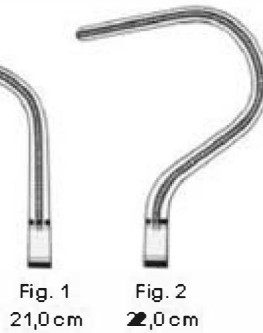

Fig. 1
21,0 cm

Fig. 2
22,0 cm



DE BAKEY SATINSKY

Fig. 1 23,0 cm **90044-23**
Fig. 2 24,0 cm **90044-24**
Fig. 3 25,0 cm **90044-25**

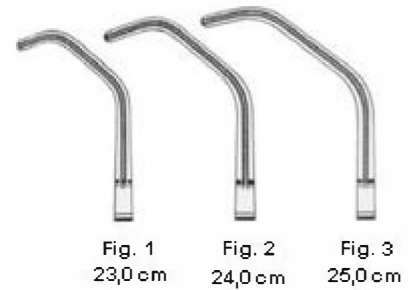

Fig. 1
23,0 cm

Fig. 2
24,0 cm

Fig. 3
25,0 cm



HARKEN

- Fig.1 25,0 cm **90045-1**
- Fig.2 24,0 cm **90045-2**
- Fig.3 24,0 cm **90045-3**
- Fig.4 24,0 cm **90045-4**



DALE
18,0 cm **90046-18**

Peripheal Gefäßklemmen
Peripheal Vascular Forceps
Pinzas para vasos periféricos



DALE
17,0 cm **90047-17**
18,0 cm **90047-18**
19,0 cm **90047-19**



DE BAKEY
17,0 cm 90048-17



BECK
17,0 cm 90049-17



DE BAKEY
24,0 cm 90050-24

Präparier- und Ligaturklemmen
Dissecting and Ligature Forceps
Pinzas de disección y ligadura



DE BAKEY
24,0 cm 90051-24



POTTS

21,0 cm **90052-21**
23,0 cm **90052-23**
27,0 cm **90052-27**
31,0 cm **90052-31**

Atraumatische Mehrzweckklemmen
Atraumatic Multi-Purpose Clamps
Pinzas atraumáticas multipropósito

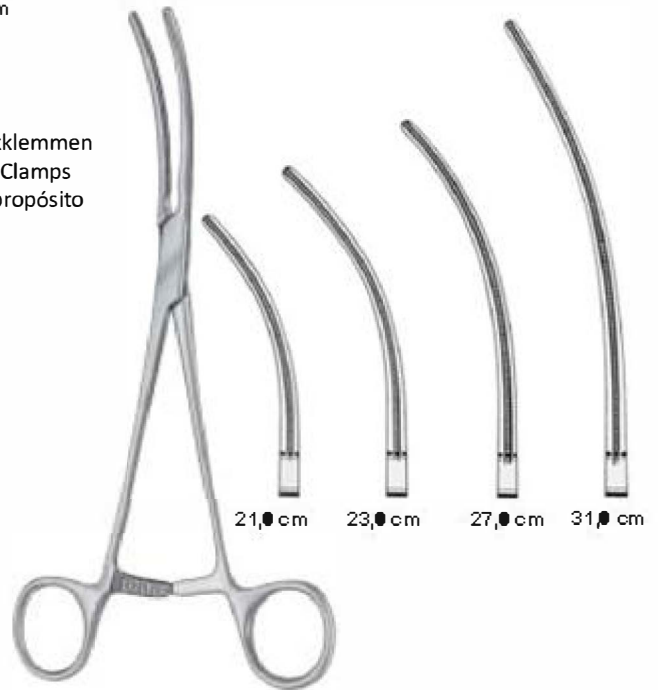

POTTS

21,0 cm **90053-21**
23,0 cm **90053-23**
27,0 cm **90053-27**
31,0 cm **90053-31**

Anastomosenklemmen, Kindergrößen
 Anastomosis Clamps, pediatric
 Pinza abrazadera anastomosis, pediátrica

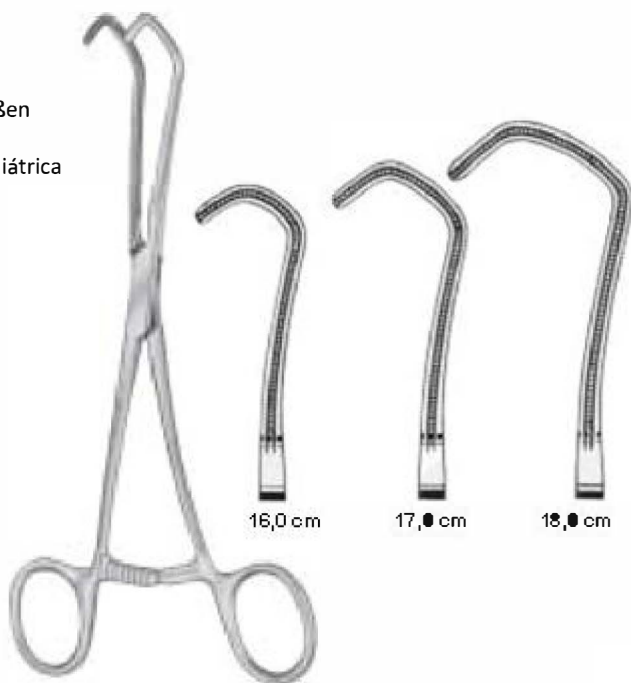

16,0 cm 17,0 cm 18,0 cm

DERRA

- 16,0 cm **90054-16**
- 17,0 cm **90054-17**
- 18,0 cm **90054-18**



DE BAKEY

16,0 cm **90055-16**

Atraumatische Mehrzweckklemmen
 Atraumatic Multi-Purpose Clamps
 Pinzas atraumáticas multipropósito



DE BAKEY

17,0 cm **90056-17**



DE BAKAY

 15,0 cm **90057-15**



DE BAKAY

 17,0 cm **90058-17**



DE BAKAY

 16,0 cm **90059-16**
 17,0 cm **90059-17**



DE BAKAY

 14,0 cm **90060-14**
 15,0 cm **90060-15**
 16,0 cm **90060-16**



Atraumatische Mehrzweckklemmen
Atraumatic Multi-Purpose Clamps
Pinzas atraumáticas multipropósito



GLOVER

 17,0 cm **90061-17**

Anastomosenklemmen
 Anastomosis Clamp
 Pinza abrazadera anastomosis

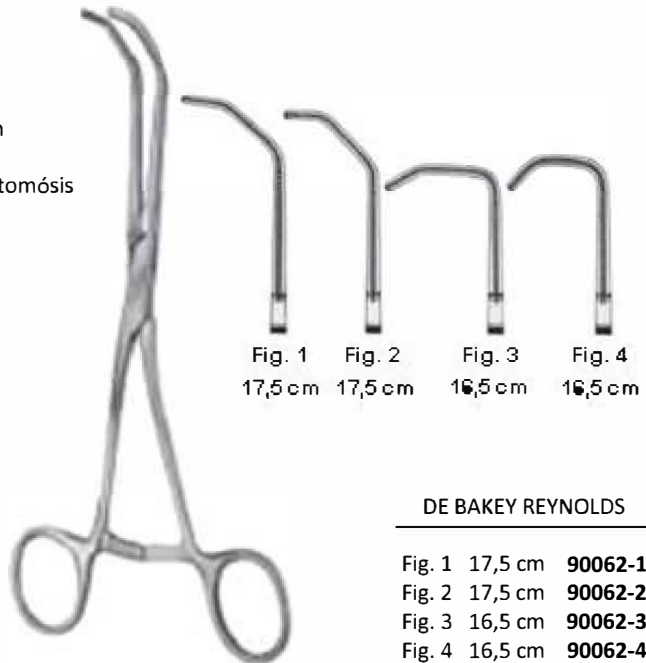

DE BAKEY REYNOLDS

- Fig. 1 17,5 cm **90062-1**
- Fig. 2 17,5 cm **90062-2**
- Fig. 3 16,5 cm **90062-3**
- Fig. 4 16,5 cm **90062-4**



SUBRAMANIAN

15,0 cm **90063-15**



SUBRAMANIAN

16,0 cm **90064-16**



SUBRAMANIAN

16,0 cm **90065-16**



OCHSNER

23,0 cm 90066-23

Aortaklemmen
Aortic Clamps
Pinzas abrazaderas aórticas



DIETRICH

21,0 cm 90067-21

Präparier- und Ligaturklemmen
 Dissecting and Ligature Forceps
 Pinzas de disección y ligadura



DE BAKEY

- 19,0 cm **90068-19**
- 20,0 cm **90068-20**
- 23,0 cm **90068-23**



JAVID

18,0 cm **90069-18**

Carotis-Shuntklemmen
 Carotid Shunt Clamps
 Pinzas abrazaderas para derivación carotídea



JAVID

19,0 cm **90070-19**

Profunda-Klemmen
 Profunda Clamps
 Pinzas abrazaderas para profunda

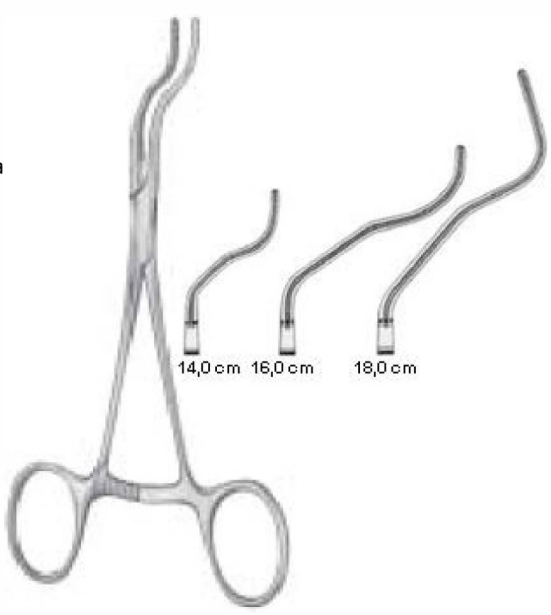

GREGORY

- 14,0 cm **90071-14**
- 16,0 cm **90071-16**
- 18,0 cm **90071-18**

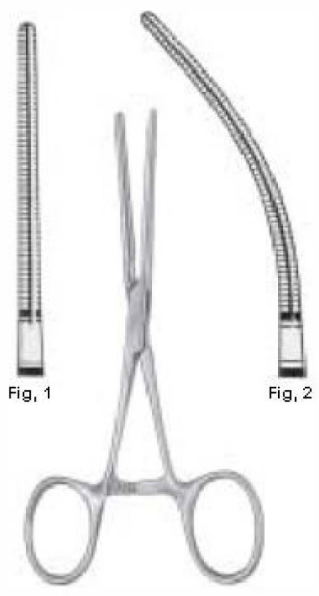

COOLEY

- Fig.1 13,0 cm **90072-1**
- Fig.2 13,0 cm **90072-2**



COOLEY

- 13,5 cm **90073-13**



COOLEY

- 13,0 cm **90074-13**



COOLEY

- 12,5 cm **90075-12**



COOLEY
 10,5 cm **90076-10**



COOLEY
 12,0 cm **90077-12**



COOLEY
 13,5 cm **90078-13**



COOLEY
 Fr./Charrière

 24 **90079-24**
 26 **90079-26**
 28 **90079-28**
 30 **90079-30**
 32 **90079-32**
 36 **90079-36**

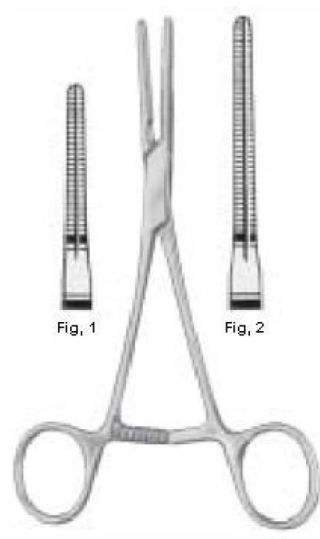

COOLEY

Gerade	Abgewinkelt
Straight	Angled
Recta	Angular

 Fig.1 14,0 cm **90080-0-14** Fig.1 14,0 cm **90080-1-14**
 Fig.2 16,0 cm **90080-0-16** Fig.2 16,0 cm **90080-1-16**



COOLEY

14,0 cm 90081-14



COOLEY

14,0 cm 90082-14



COOLEY

14,0 cm 90083-14



COOLEY

27,0 cm 90084-27



COOLEY

17,0 cm 90085-17

Atraumatische Mehrzweckklemmen
 Atraumatic Multi-Purpose Clamps
 Pinzas atraumáticas multipropósito



Fig. 1 17,0 cm
 Fig. 2 17,0 cm
 Fig. 3 17,0 cm

COOLEY

- Fig.1 17,0 cm **90086-1**
- Fig.2 17,0 cm **90086-2**
- Fig.3 17,0 cm **90086-3**

Iliaca-Klemme
 Iliac Clamps
 Pinzas abrazaderas iliaca



COOLEY

21,5 cm **90087-21**

Anastomosenklemmen
 Anastomosis Clamps
 Pinza abrazadera anastomosis



COOLEY

17,0 cm **90088-17**



COOLEY
 90089-0-14 14,0 cm 90089-1-14



COOLEY
 14,0 cm 90090-14



COOLEY
 14,0 cm 90091-14



COOLEY
 15,0 cm 90092-15
 16,0 cm 90092-16

Atraumatische Mehrzweckklemmen
Atraumatic Multi-Purpose Clamps
Pinzas atraumáticas multipropósito



COOLEY

16,5 cm **90093-16**



COOLEY

16,5 cm **90094-16**



COOLEY

16,5 cm **90095-16**



COOLEY

14,0 cm **90096-14**

Anastomosenklemmen
Anastomosis Clamps
Pinza abrazadera anastomosis

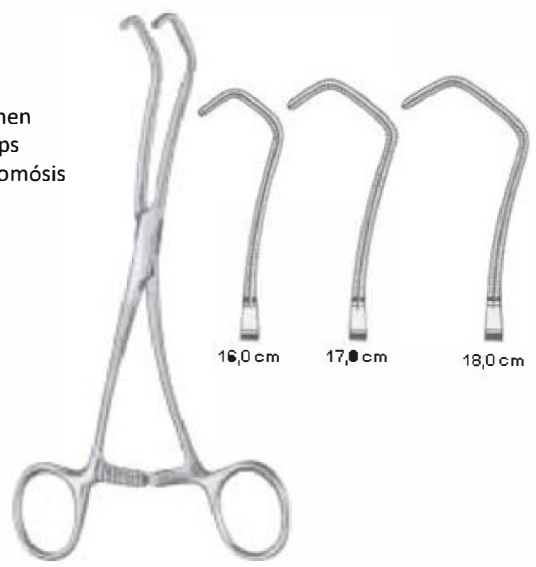

COOLEY DERRA

16,0 cm **90097-16**
 17,0 cm **90097-17**
 18,0 cm **90097-18**



Anastomosenklemmen
 Anastomosis Clamps
 Pinza abrazadera anastomosis

COOLEY

Fig.1 17,0 cm **90098-1**
 Fig.2 17,0 cm **90098-2**



COOLEY

16,0 cm **90099-1**
 17,5 cm **90099-2**
 17,5 cm **90099-3**



COOLEY

17,0 cm 90100-17



COOLEY

17,0 cm 90101-17



COOLEY

18,0 cm 90102-18



COOLEY

19,0 cm 90103-19



COOLEY

26,0 cm 90104-26



COOLEY

27,0 cm 90105-27



Neonatal- und Kinderklemmen, extra feine Modelle
 Neonatal and Children Clamps, extra delicate patterns
 Pinza abrazadera para neonatos y niños, diseño extra delicado

CASTAÑEDA

13,0 cm **90106-13**

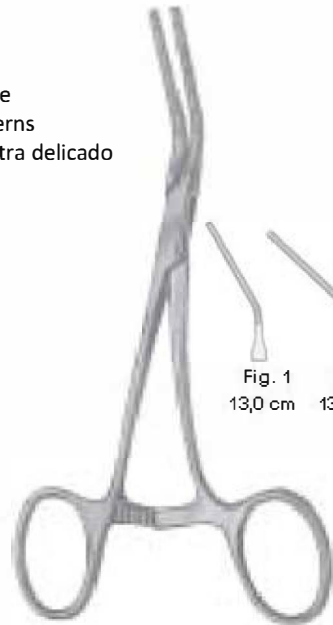

Fig. 1 13,0 cm
 Fig. 2 13,0 cm
 Fig. 3 13,0 cm
 Fig. 4 13,0 cm

CASTAÑEDA

Fig.1 13,0 cm **90107-1**
 Fig.2 13,0 cm **90107-2**
 Fig.3 13,0 cm **90107-3**
 Fig.4 13,0 cm **90107-4**

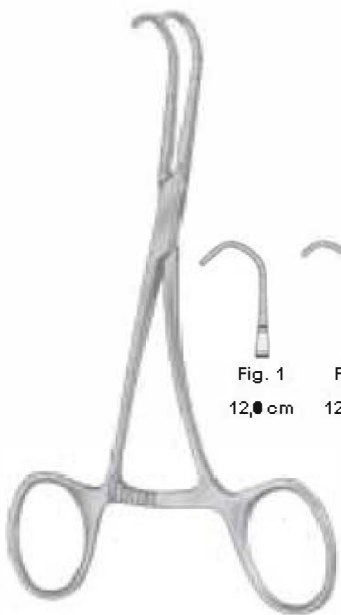

Fig. 1 12,0 cm
 Fig. 2 12,0 cm
 Fig. 3 12,0 cm
 Fig. 4 12,0 cm

CASTAÑEDA

Fig.1 12,0 cm **90108-1**
 Fig.2 12,0 cm **90108-2**
 Fig.3 12,0 cm **90108-3**
 Fig.4 12,0 cm **90108-4**

Kinder-Gefäßklemmen Pediatric
 Vascular Clamps
 Pinza abrazadera pediátrica vascular

Gerade
 Straight
 recto

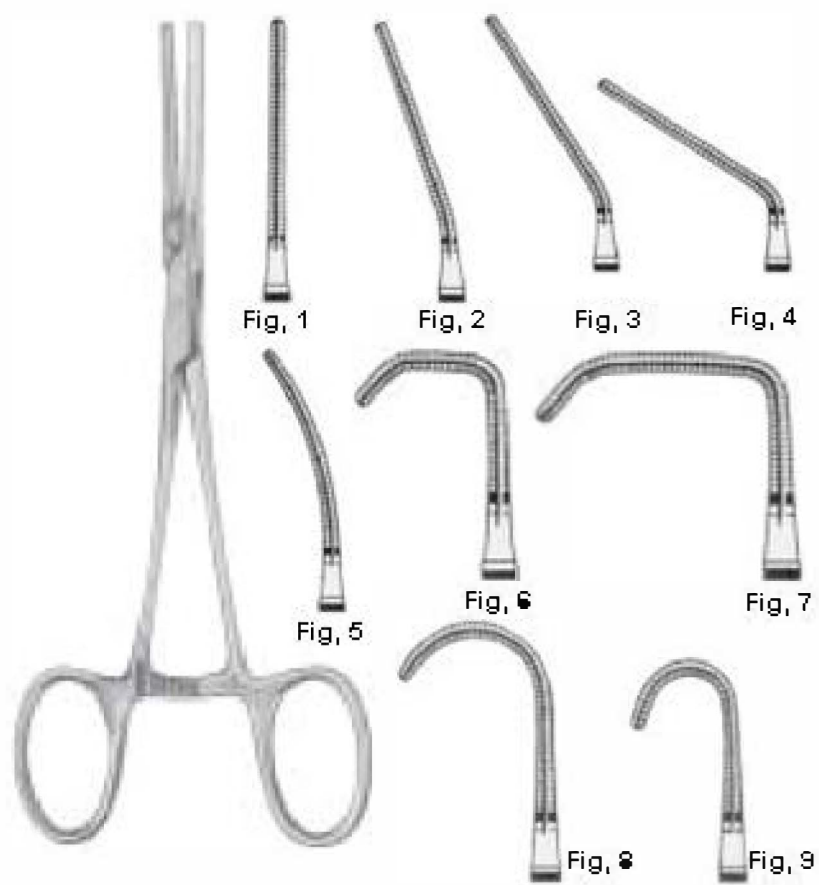

- Fig.1 **90109-1**
- Fig.2 **90109-2**
- ~~Fig.3 **90109-3**~~
- Fig.4 **90109-4**
- Fig.5 **90109-5**
- ~~Fig.6 **90109-6**~~
- Fig.7 **90109-7**
- Fig.8 **90109-8**
- Fig.9 **90109-9**

Kinder-Gefäßklemmen
Pediatric Vascular Clamps
Pinza abrazadera pediátrica vascular

Abgewinkelt
Angled
Angulado

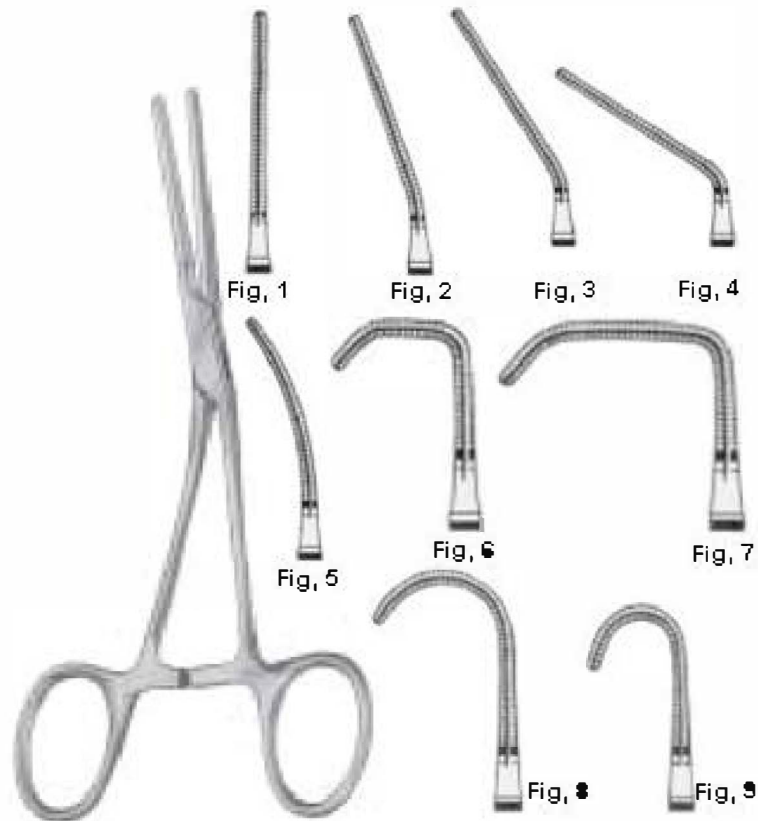

- Fig.1 **90110-1**
- Fig.2 **90110-2**
- ~~Fig.3 **90110-3**~~
- Fig.4 **90110-4**
- Fig.5 **90110-5**
- ~~Fig.6 **90110-6**~~
- Fig.7 **90110-7**
- Fig.8 **90110-8**
- Fig.9 **90110-9**

Kinder-Gefäßklemmen
 Pediatric Vascular Clamps
 Pinza abrazadera pediátrica vascular

Stark abgewinkelt
 Strongly angled
 Gran angulación

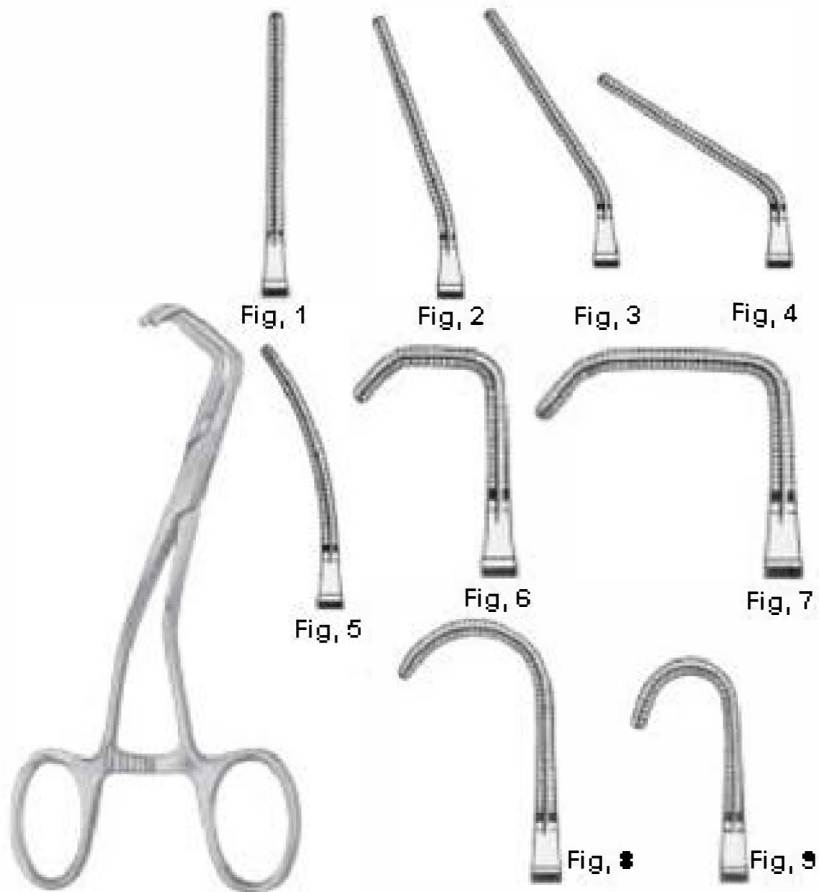

- Fig.1 **90111-1**
- Fig.2 **90111-2**
- ~~Fig.3 **90111-3**~~
- Fig.4 **90111-4**
- Fig.5 **90111-5**
- ~~Fig.6 **90111-6**~~
- Fig.7 **90111-7**
- Fig.8 **90111-8**
- Fig.9 **90111-9**

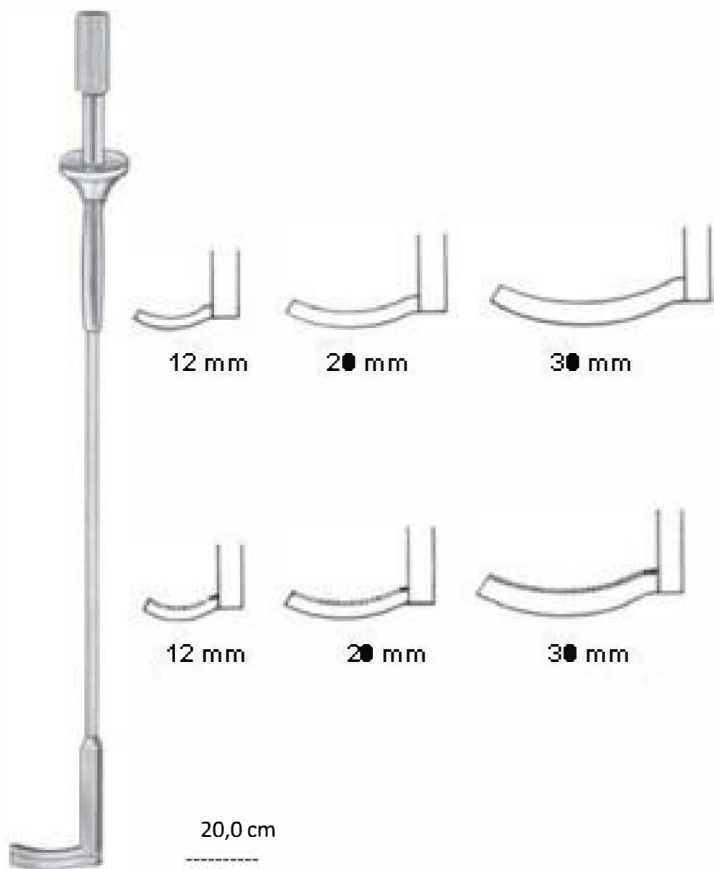

12 mm

20 mm

30 mm

12 mm

20 mm

30 mm

20,0 cm

12 mm **90112-0-12**

20 mm **90112-0-20**

30 mm **90112-0-30**

mit Riefung/Serrated/Aserrado

12 mm **90112-1-12**

20 mm **90112-1-20**

30 mm **90112-1-30**



ø 3 mm

ø 5 mm

ø 7 mm

ø 9 mm

ø 3 mm **90113-3**

ø 5 mm **90113-5**

ø 7 mm **90113-7**

ø 9 mm **90113-9**